

# KENWOOD

COMPACT HIFI SYSTEM

## XD SERIES

XD-A31

XD-302

XD-352

XD-372S

---

## INSTRUCTION MANUAL

KENWOOD CORPORATION

This instruction manual is used to describe multiple models listed above.  
Model availability and features (functions) may differ depending on the country and sales area.



## 2 Before applying power

**! Caution : Read this page carefully to ensure safe operation.**

XD SERIES (En)

Units are designed for operation as follows.

U.S.A. and Canada ..... AC 120 V only  
 Austraria ..... AC 240 V only

Europe and U.K. .... AC 230 V only  
 \*Other countries ..... AC 110-120 /220-240 V switchable

### AC voltage selection

This unit operates on 110-120 or 220-240 volts AC . The AC voltage selector switch on the rear panel is set to the voltage that prevails in the area to which the unit is shipped. Before connecting the power cord to your AC outlet, make sure that the setting position of this switch matches your line voltage. If not, it must be set to your voltage in accordance with the following direction.

### AC voltage selector switch

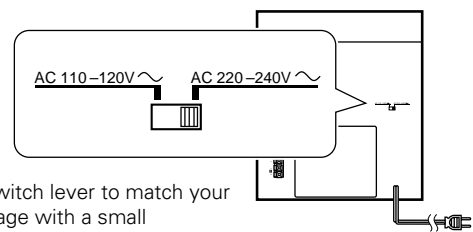

Move switch lever to match your line voltage with a small screwdriver or other pointed tool.

### Note:

Our warranty does not cover damage caused by excessive line voltage due to improper setting of the AC voltage selector switch.

## Safety precautions

**WARNING :** TO PREVENT FIRE OR ELECTRIC SHOCK, DO NOT EXPOSE THIS APPLIANCE TO RAIN OR MOISTURE.

	<p><b>CAUTION</b>                  RISK OF ELECTRIC SHOCK                  DO NOT OPEN</p>		<p>CAUTION: TO REDUCE THE RISK OF ELECTRIC SHOCK, DO NOT REMOVE COVER (OR BACK). NO USER-SERVICEABLE PARTS INSIDE, REFER SERVICING TO QUALIFIED SERVICE PERSONNEL.</p>
	<p>THE LIGHTNING FLASH WITH ARROWHEAD SYMBOL, WITHIN AN EQUILATERAL TRIANGLE, IS INTENDED TO ALERT THE USER TO THE PRESENCE OF UNINSULATED "DANGEROUS VOLTAGE" WITHIN THE PRODUCT'S ENCLOSURE THAT MAY BE OF SUFFICIENT MAGNITUDE TO CONSTITUTE A RISK OF ELECTRIC SHOCK TO PERSONS.</p>		
	<p>THE EXCLAMATION POINT WITHIN AN EQUILATERAL TRIANGLE IS INTENDED TO ALERT THE USER TO THE PRESENCE OF IMPORTANT OPERATING AND MAINTENANCE (SERVICING) INSTRUCTIONS IN THE LITERATURE ACCOMPANYING THE APPLIANCE.</p>		



### The marking of products using lasers (Except for some areas)



The marking is located on the rear panel and says that the component uses laser beams that have been classified as Class 1. It means that the unit is utilizing laser beams that are of a weaker class. There is no danger of hazardous radiation outside the unit.

# Contents

## Preparation

-  **Before applying power** ..... 2
  -  **Safety precautions** ..... 2
  - Contents** ..... 3
  - CHANNEL SPACE setting** ..... 3
  - Special features** ..... 4
  - Demonstration** ..... 4
  - Accessories** ..... 4
-  **IMPORTANT SAFEGUARDS** ..... 5
- Handling of discs and tapes** ..... 7
- system connection** ..... 8
  - AM loop antenna connection** ..... 8
  - FM antenna connection** ..... 8
  - Connection of the speaker system** ..... 9
  - Connection of options (Optional parts)** ..... 9
- Controls and indicators** ..... 10
  - CD and Receiver unit** ..... 10
  - Cassette deck unit** ..... 11
  - Display** ..... 11
- Operation of remote control unit** ..... 12
  - Clock adjustment** ..... 13

## Operation

- Let's put out some sound** ..... 14
  - Basic use method** ..... 14
  - Muting the sound temporarily** ..... 15

- Listening through headphones** ..... 15
- Changing the Tone (Selecting the equalizer pattern)** ..... 15
- Changing the Tone (Selecting the bass boost)** ..... 15
- Playback of CDs** ..... 16
  - Sequential playback from the first track** ..... 16
  - Playback from the desired track** ..... 17
  - Listening in the desired sequence (program playback)** ..... 18
  - Repeat Playback** ..... 20
  - Random Playback** ..... 21
- Receiving broadcast station** ..... 22
  - Collective presetting of stations (auto preset)** ..... 23
  - One-by-one presetting (manual preset)** ..... 23
- Playback of tapes** ..... 24
- Recording (Deck B only)** ..... 26
  - Copying tape (Tape dubbing)** ..... 28
- Convenient CD recording** ..... 29
  - Recording only desired titles (CD ONE TRACK RECORDING)** ..... 30
  - Recording of an entire CD (CD DIRECT RECORDING)** ..... 31
  - Recording the programmed titles (CD PROGRAM RECORDING)** ..... 32
- Timer operation** ..... 34
  - Sleep timer (SLEEP)** ..... 34
  - Timer programming** ..... 35

## Knowledge

- Important Items** ..... 38
- In case of difficulty** ..... 39
- Specifications** ..... 42

# CHANNEL SPACE setting

(Except for the U.S.A., Canada, U.K. Europe and Australia)

The space between radio channels has been set to the one that prevails in the area to which the system is shipped. However, if the current channel space setting does not match the setting in the area where the system is to be used, for instance when you move from area 1 or area 2 shown in the following table or vice versa, proper reception of AM/FM (SW/MW/FM) broadcasts cannot be expected. In this case, change the channel space setting in accordance with your area by referring to the following table.

Area		CHANNEL SPACE freq.
1	USA, Canada and South American countries	FM : 100 kHz AM : 10 kHz
2	Other countries	FM : 50 kHz AM : 9 kHz

- ① Select the TUNER input.
- ② While holding the SELECT key depressed, turn the SOUND CONTROL jog dial to select the system mode.

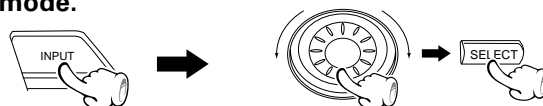

- ① "FM100/AM10 kHz" STEP,
- ② "FM 50 /AM 9 kHz" STEP,



- The "AM" display is variable depending on the model (country or area), and "MW" may be displayed in some areas.

- ③ Establish the selection.



# Special features

## 3-Disc carousel CD player

Three discs can be set. There are various ways for enjoyment at the time of program play back, repeat playback, random playback, etc.

## Double cassette deck

Two tape decks are installed, permitting dubbing from tape to tape and relay playback.

## Simplified operations using large-sized Jog Dial

This dial allows you to set the CD program and timer-related operations while observing the operating conditions shown by the display and icons.

## 3D large-sized color display panel

The large sound level meter represents the movement in music with brilliant colors to offer the joy of viewing the music at the same time as listening.

## Convenient Timer Functions

An ON/OFF timer for listening at the same time each day and a sleep timer are provided.

## Demonstration

When the power supply is restored after a power failure or the power cord is unplugged and plugged in again during use, this unit automatically starts the demonstration function (display only). During the demonstration, the display changes in sequence but the audio does not change. The demonstration can be canceled with the following procedure.

### To switch over the demonstration :



Turn the unit OFF (STANDBY mode) and press the key.

Each press of the key switches the demonstration as shown below.

- ① "Demo on" (Demonstration executed)
- ② "Demo off" (Demonstration canceled)

- The setting is remembered even when the power is switched off.

## Unpacking

Unpack the unit carefully and make sure that all accessories are put aside so they will not be lost.

Examine the unit for any possibility of shipping damage. If your unit is damaged or fails to operate, notify your dealer immediately. If your unit was shipped to you directly, notify the shipping company without delay. Only the consignee (the person or company receiving the unit) can file a claim against the carrier for shipping damage.

We recommend that you retain the original carton and packing materials for use should you transport or ship the unit in the future.

Keep this manual handy for future reference.

## Accessories

### FM indoor antenna (1)

#### Europe and U.K.

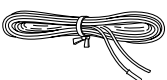

#### Other countries

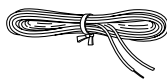

### Remote control unit (1)

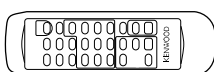

### AM loop antenna (1)

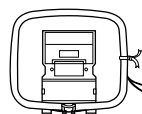

### Batteries (R6/AA) (2)



### AC plug adaptor (1)

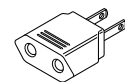

Use to adapt the plug on the power cord to the shape of the wall outlet. (Accessory only for regions where use is necessary.)

Please read all of the safety and operating instructions before operating this appliance. Adhere to all warnings on the appliance and in the instruction manual. Follow all the safety and operating instructions. These safety and operating instructions should be retained for future reference.

- 1. Power sources** – The appliance should be connected to a power supply only of the type described in the instruction manual or as marked on the appliance. If you are not sure of the type of power supply to your home, consult your appliance dealer or local power company. For appliances intended to operate from battery power, or other sources, refer to the instruction manual.
- 2. Power-cord protection** – Power-supply cords should be routed so that they are not likely to be walked on or pinched by items placed upon or against them, pay particular attention to cords at plugs, convenience receptacles, and the point where they exit from the appliance.

Never pull or stretch the cord.

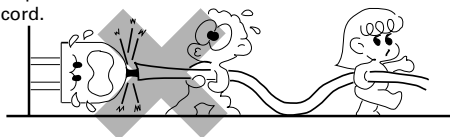

- 3. CAUTION – Polarization** – This appliance may be equipped with a polarized alternating-current line plug (a plug having one blade wider than the other). This plug will fit into the power outlet only one way. This is a safety feature. If you are unable to insert the plug fully into the outlet, try reversing the plug. If the plug should still fail to fit, contact your electrician to replace your obsolete outlet. Do not defeat the safety purpose of the polarized plug.
- 4. Ventilation** – Slots and openings in the cabinet are provided for ventilation and to ensure reliable operation of the appliance and to protect it from overheating, and these openings must not be blocked or covered. The appliance should be situated so that its location or position does not interfere with its proper ventilation.  
To maintain good ventilation, do not put records or a tablecloth on the appliance. Place the appliance at least 10 cm away from the walls.  
Do not use the appliance on a bed, sofa, rug or similar surface that may block the ventilation openings. This appliance should not be placed in a built-in installation such as a bookcase or rack unless proper ventilation is provided or the manufacturer's instructions have been adhered to.

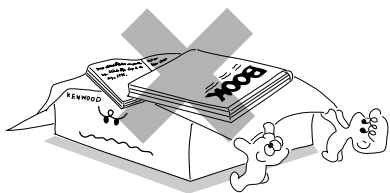

- 5. Water and moisture** – The appliance should not be used near water - for example, near a bathtub, washbowl, kitchen sink, laundry tub, in a wet basement, or near a swimming pool, etc.

- 6. Temperature** – The appliance may not function properly if used at extremely low, or freezing temperatures. The ideal ambient temperature is above +5°C (41°F).
- 7. Heat** – The appliance should be situated away from heat sources such as radiators, heat registers, stoves, or other appliances (including amplifiers) that produce heat.
- 8. Electric shock** – Care should be taken so that objects do not fall and liquid is not spilled into the enclosure through openings. If a metal objects, such as a hair pin or a needle, comes into contact with the inside of this appliance, a dangerous electric shock may result. For families with children, never permit children to put anything, especially metal, inside this appliance.

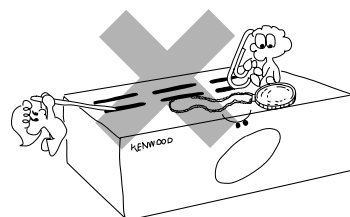

- 9. Enclosure removal** – Never remove the enclosure. If the internal parts are touched accidentally, a serious electric shock might occur.

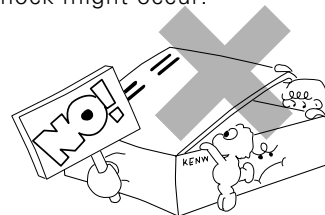

- 10. Magnetic fields** – Keep the appliance away from sources of magnetic fields such as TV sets, speaker systems, radios, motorized toys or magnetized objects.
- 11. Cleaning** – Unplug this appliance from the wall outlet before cleaning. Do not use volatile solvents such as alcohol, paint thinner, gasoline, or benzine, etc. to clean the cabinet. Use a clean dry cloth.
- 12. Accessories** – Do not place this appliance on an unstable cart, stand, tripod, bracket, or table. The appliance may fall, causing serious injury to a child or adult, and serious damage to the appliance. Use only with a cart, stand, tripod, bracket, or table recommended by the manufacturer, or sold with the appliance. Any mounting of the appliance should follow the manufacturer's instructions, and should use a mounting accessory recommended by the manufacturer. An appliance and cart combination should be moved with care. Quick stops, excessive force, and uneven surfaces may cause the appliance and cart combination to overturn.



**13. Lightning** – For added protection for this appliance during a lightning storm, or when it is left unattended and unused for long periods of time, unplug it from the wall outlet and disconnect the antenna or cable system. This will prevent damage to the appliance due to lightning and power-line surges.

**14. Abnormal smell** – If an abnormal smell or smoke is detected, immediately turn the power OFF and unplug the appliance from the wall outlet. Contact your dealer or nearest service center.

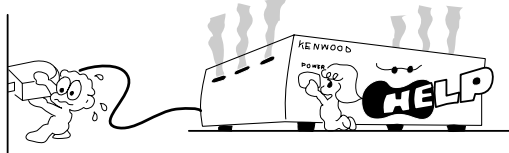

**15. Damage requiring service** – The appliance should be serviced by qualified service personnel when:

- A.** The power-supply cord or the plug has been damaged.
- B.** Objects have fallen, or liquid has been spilled into the appliance.
- C.** The appliance has been exposed to rain or water.
- D.** The appliance does not appear to operate normally by following the instruction manual. Adjust only those controls that are covered by the instruction manual as an improper adjustment of other controls may result in damage and will often require extensive work by a qualified technician to restore the appliance to its normal operation.
- E.** The appliance has been dropped, or the enclosure damaged.
- F.** The appliance exhibits a marked change in performance.

**16. Servicing** – The user should not attempt to service the appliance beyond that described in the instruction manual. All other servicing should be referred to qualified service personnel.

**17. Outdoor antenna grounding** – If an outside antenna is connected to the appliance, be sure the antenna system is grounded so as to provide some protection against voltage surges and built up static charges. Article 810 of the National Electrical Code ANSI/NFPA 70, provides information with respect to proper grounding of the mast and supporting structure, grounding of the lead-in wire to an antenna discharge unit, size of grounding conductors, location of antenna discharge unit, connection to grounding electrodes, and requirements for the grounding electrode. See Figure.

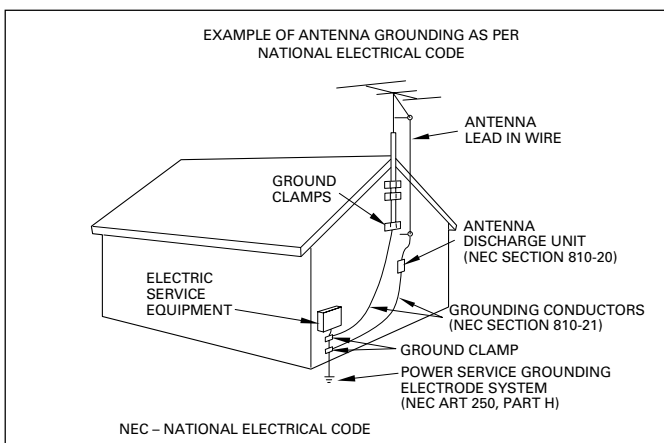

**18. Power lines** – An outside antenna system should not be located in the vicinity of overhead power lines or other electric light or power circuits, or where it can fall into such power lines or circuits. When installing an outside antenna system, extreme care should be taken to keep from touching such power lines or circuits as contact with them might be fatal.

**19. AC outlets** – Do not connect other audio equipment with a power consumption larger than that specified to the AC outlet on the rear panel. Never connect other electrical appliances, such as an iron or toaster, to it to prevent fire or electric shock.

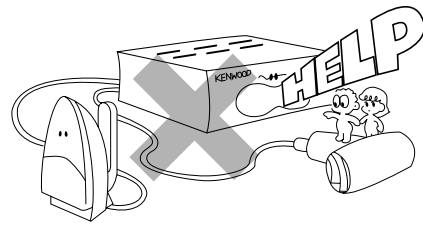

**20. Overloading** – Do not overload wall outlets, extension cords, or integral convenience receptacles as this can result in a risk of fire or electric shock.

**21. Attachment** – Do not use attachments not recommended by the appliance manufacturer as they may cause hazards.

**22. Replacement parts** – When replacement parts are required, be sure the service technician has used replacement parts specified by the manufacturer or have the same characteristics as the original parts. Unauthorized substitutions may result in fire, electric shock, or other hazards.

**23. Safety check** – Upon completion of any service or repairs to this appliance, ask the service technician to perform safety checks to determine that the appliance is in proper operating condition.

Notes:

1. Item 3 is not required except for grounded or polarized equipment.
2. Item 17 and 18 are not required except for units provided with antenna terminals.
3. Item 17 complies with UL in the U.S.A.

## Disc handling precautions

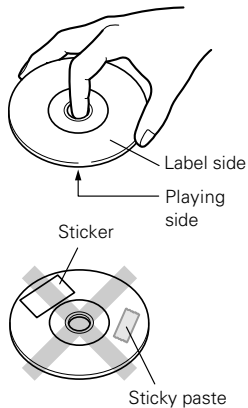

### Handling

Hold compact discs so that you do not touch the playing surface.

- Do not attach paper or tape to either the playing side or the label side of compact discs.
- The paste left on the label surface after a sticker has been peeled off is a factor which may cause malfunction. If the surface is sticky due to remaining paste, be sure to clean it with alcohol before use.

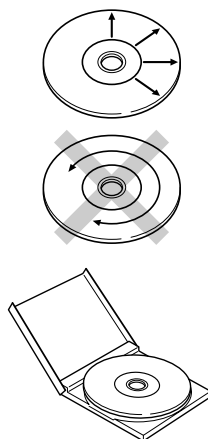

### Cleaning

If fingerprints or foreign matter become attached to the disc, lightly wipe the disc with a soft cotton cloth (or similar) from the center of the disc outwards, in a radial manner.

### Storage

When a disc is not to be played for a long period of time, remove it from the CD player and store it in its case.

## Caution on disc used

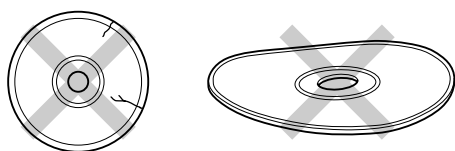

### Never play a cracked or warped disc.

During playback, the disc rotates at high speed in the player. Therefore, to avoid danger, never use a cracked or deformed disc or a disc repaired with tape or adhesive agent.

### Do not use cleaning discs.

Please do not use commercially available cleaning discs, they may damage the internal mechanism.

## Discs which can be played with this unit

### CD (12 cm, 8 cm)

- With CD-G (CD Graphics) discs, this unit can play only the audio.

## Notes on cassette tape

### Safety tab (accidental erasure prevention tab)

After an important recording has been finished, break the safety tab, to prevent the recorded contents from being erased or recorded on accidentally.

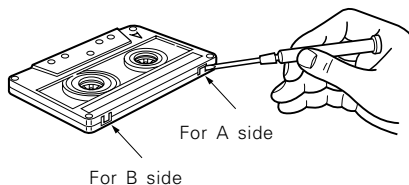

### To store cassette tapes

Do not store the tapes in a place which is subject to direct sunlight, or near equipment that generates heat. Keep the cassette tapes away from any magnetic field.

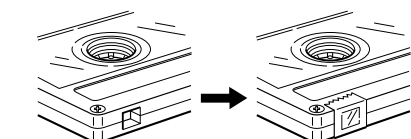
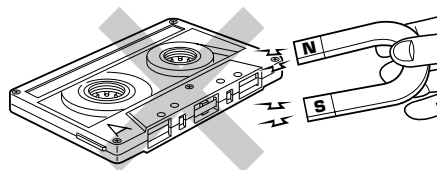

### To re-record

Apply tape only to the position where the tab has been removed.

### When there is slack in the tape

In such a case, insert a pencil into the reel hole and wind the reel hub to remove the slack.

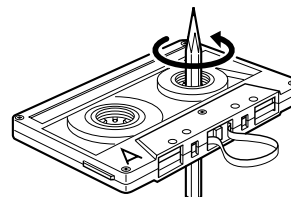

### 1. Longer tape than 110 minutes cassette tape

Since longer tape than 110 minutes cassette tape is very thin, the tape could adhere to the pinch roller or be easily cut. It is recommended that these tapes not be used with this unit to prevent possible damage.

### 2. Endless tapes

Do not use an endless tape, as this could damage the mechanism of the unit.

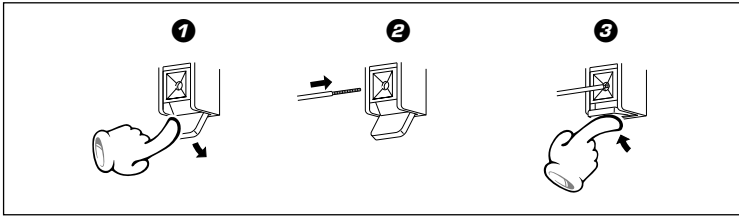

## Caution regarding placement

To maintain proper ventilation, be sure to leave a space around the unit (from the largest outer dimensions including projections) equal to, or greater than, shown below.

Rear panel: 10 cm

## AM loop antenna connection

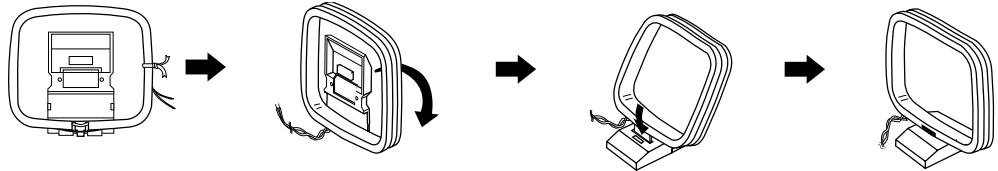

## AM loop antenna connection

The supplied antenna is for indoor use. Place it as far as possible from the main system, TV set, speaker cords and power cord, and set it to a direction which provides the best reception.

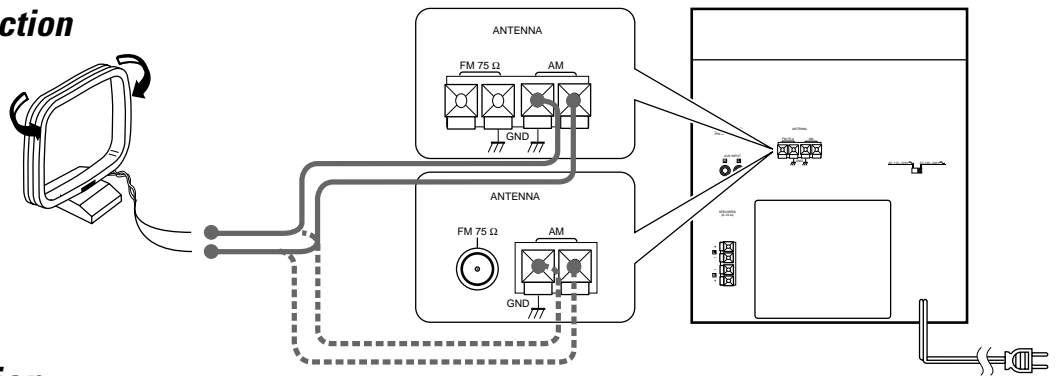

## FM antenna connection

### FM indoor antenna connection

The accessory antenna is for temporary indoor use only. For stable signal reception we recommend using an outdoor antenna. Remove the indoor antenna if you connect one outdoors.

- ❶ Strip the coating from the tip of cord and twist the conductor. (Except for Europe and U.K.)
- ❷ Connect to the antenna terminal.
- ❸ Locate the position providing good reception condition.
- ❹ Fix the antenna.

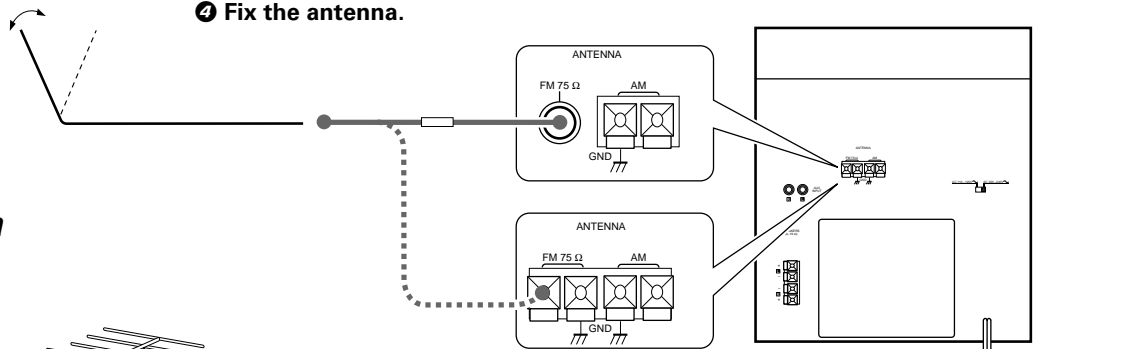

### FM outdoor antenna

Lead the 75Ω coaxial cable connected to the FM outdoor antenna into the room and connect it to the FM 75Ω terminal.

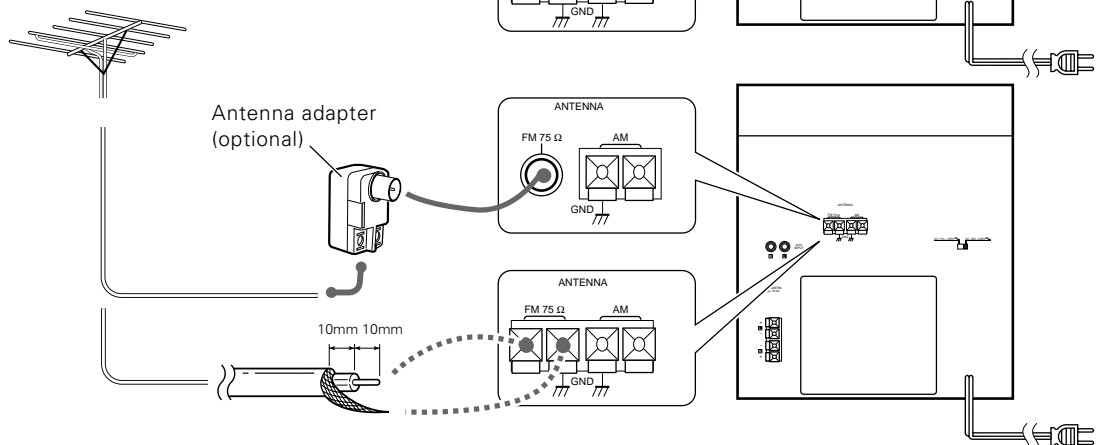



Do not plug the power cord into the power outlet until all of the required connections have been made.

### Connection of the speaker system

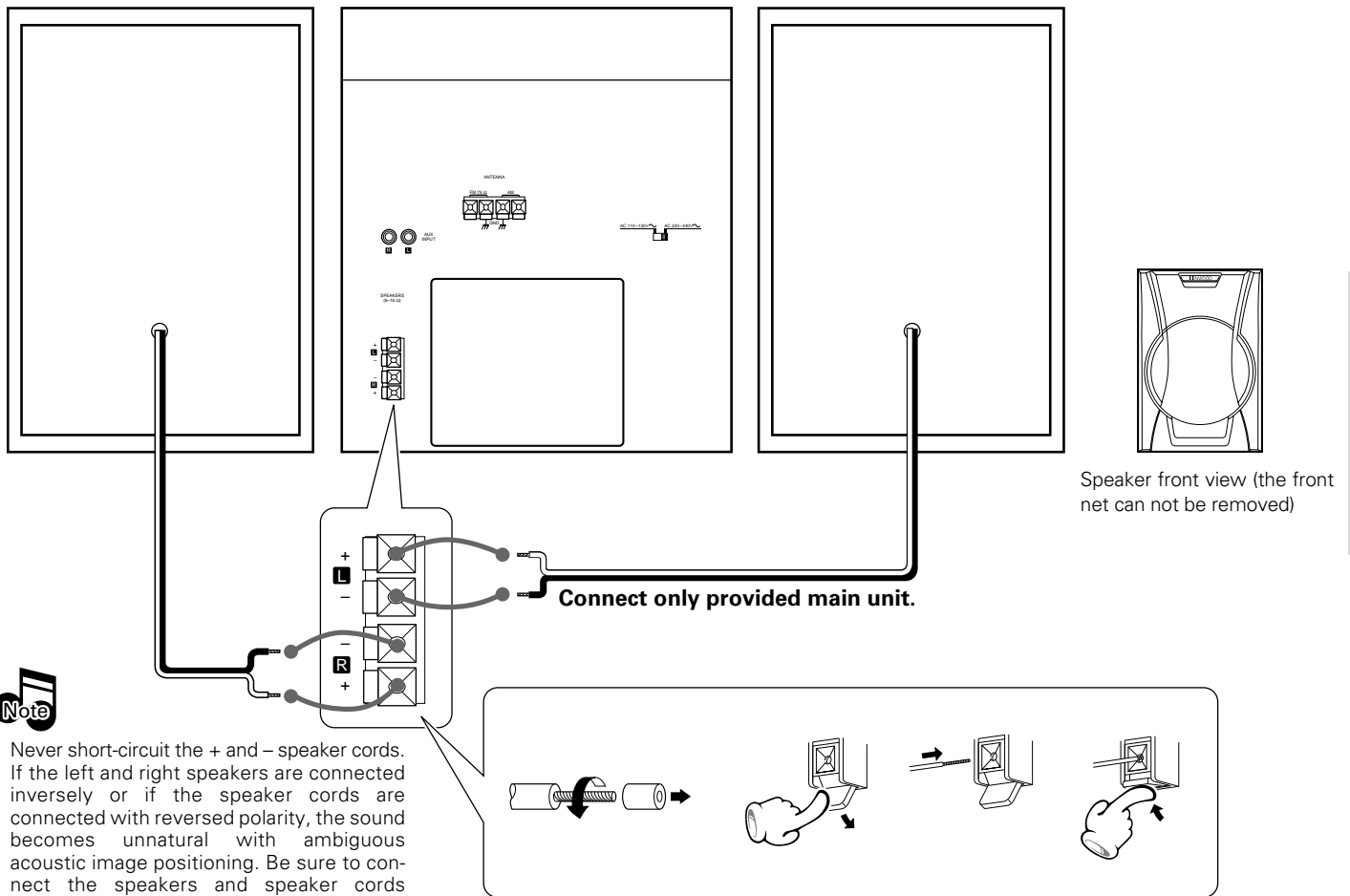

### Connection of options (Optional parts)

Connect separately sold parts as shown in the figure. Do not plug the power cord into the power outlet until all of the required connections have been made.

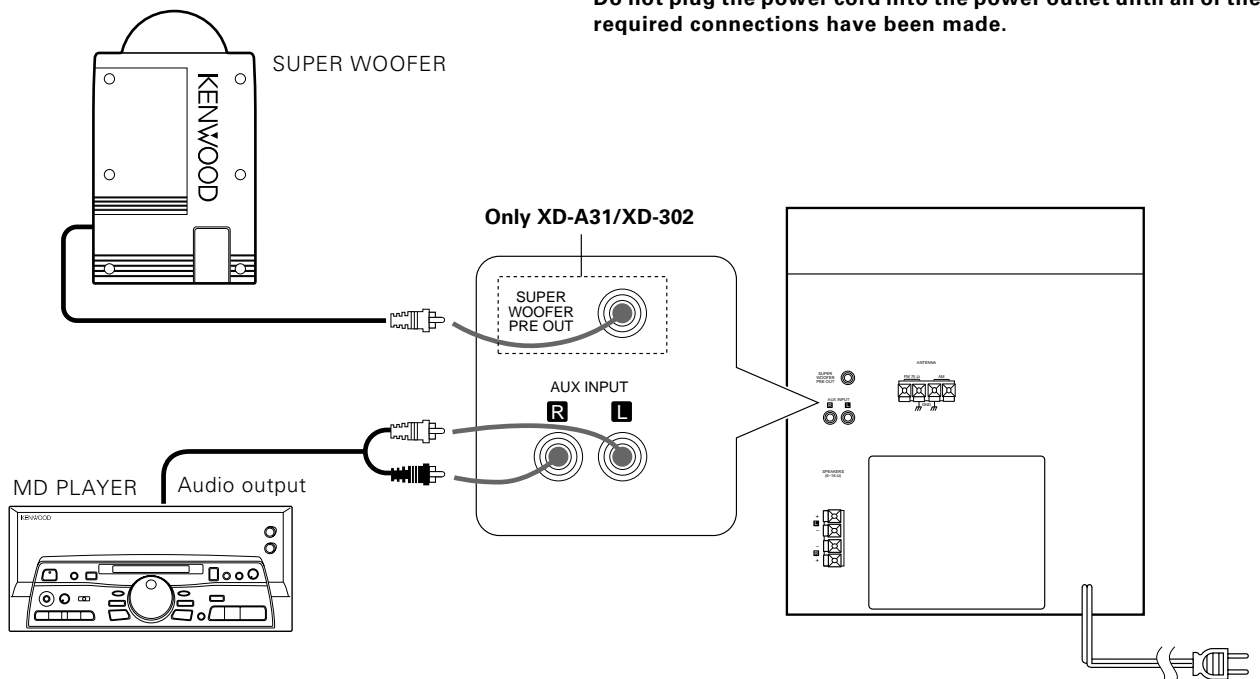

**CD and Receiver unit**

Preparation

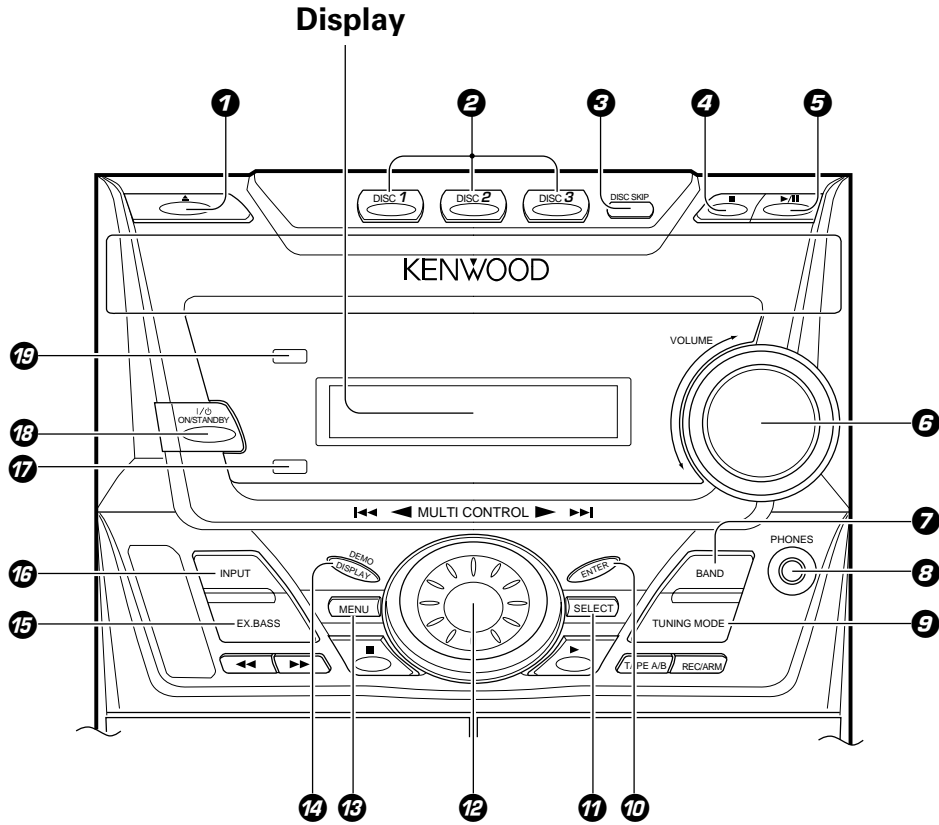

- 1 OPEN/CLOSE (▲) key** → 16  
The disc tray is opened and closed.
- 2 Disc selection keys** → 17  
The disc number is selected directly and playback starts.
- 3 DISC SKIP key** → 17  
Used to skip discs.
- 4 Stop (■) key** → 16
- 5 Play/pause (▶/⏸) key** → 16
- 6 VOLUME CONTROL knob** → 14  
This is used for volume adjustment.
- 7 BAND key** → 22  
Press to switch the receiving band.
- 8 PHONES terminal** → 15  
For connection of a headphone (optional).
- 9 TUNING MODE key** → 22  
Switches the tuning mode.
- 10 ENTER key** → 18  
Used for entering a selected mode in memory or executing it.
- 11 SELECT key** → 18  
Used for setting of various modes or establishing a selection.
- 12 MULTI CONTROL jog dial** → 18  
Turn this dial to select optimum modes according to the desired operations.  
When the CD input is selected, this dial is used to skip tracks.  
When the TUNER input is selected, this dial is used to select a station.
- 13 MENU key** → 18  
Press to switch the mode set with the MULTI CONTROL jog dial ON or OFF.
- 14 DISPLAY/DEMO key** → 4 → 15  
Switches the display contents.  
**\*Used for demonstration (DEMO) ON/OFF.**
- 15 EX. BASS (Extra bass) key** → 15  
Switches the extra bass play on and off.
- 16 INPUT key** → 14  
Key for input switching.
- 17 TIMER indicator**  
Lights up when the timer is set.
- 18 ON/STANDBY (I/O) key** → 14  
**ON/STANDBY (POWER) key (For U.S.A. Canada)**  
Power ON/OFF switching is executed.
- 19 STANDBY indicator**

## Cassette deck unit

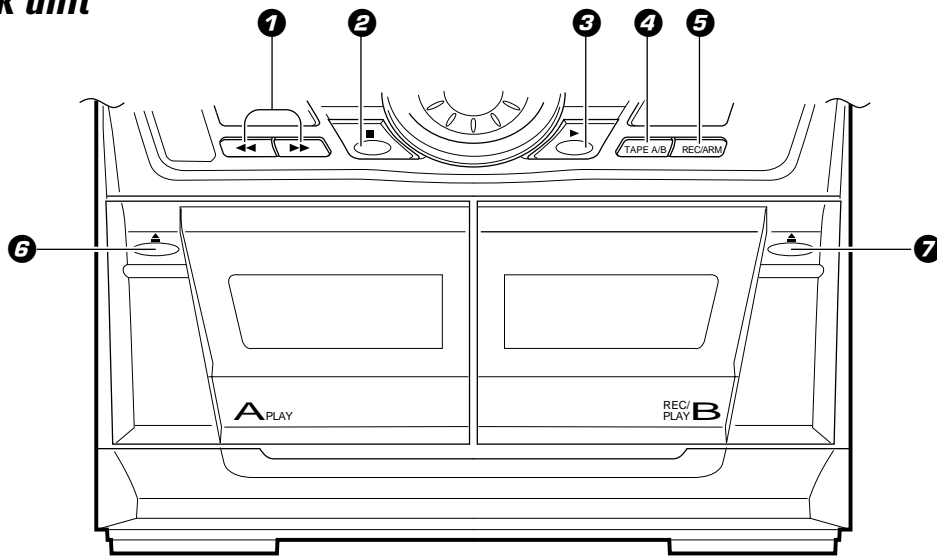

- ❶ Fast forward and rewind (◀◀, ▶▶) keys
- ❷ Stop (■) key
- ❸ Play (▶) key
- ❹ TAPE A/B selection key
- ❺ REC/ARM key

→ 25  
→ 25  
→ 24  
→ 24  
→ 26

### ❻ TAPE A Cassette holder

Press the ▲ section of cassette holder to remove and insert Tape A is used exclusively for playback.

→ 24

### ❼ TAPE B Cassette holder

The Tape B Auto Reverse function can operate in Record and Playback modes.

→ 24

## Display

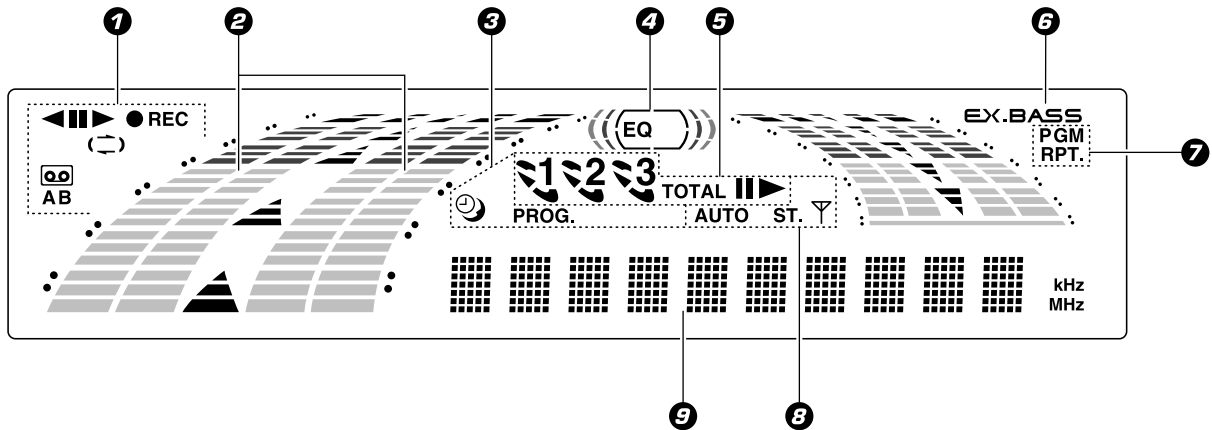

### ❶ Cassette deck-related indicators

This section contains the cassette deck operation indicators. The indicated information includes the tape reverse mode and tape transport direction.

### ❷ Sound level meter

The display varies according to the music or the operations of the CD, tape, etc.

During the volume adjustment, this meter displays the current sound level as a reference.

### ❸ Timer-related indicators

### ❹ Equalizer indicators

### ❺ CD player-related indicators

This section contains the CD play and pause mode indicators. It also shows the disc number being selected.

### ❻ EX.BASS indicator

### ❼ PGM/RPT. indicators

### ❽ Tuner-related indicators

### ❾ Character information display

Displays the input selection, frequency, volume level, etc.

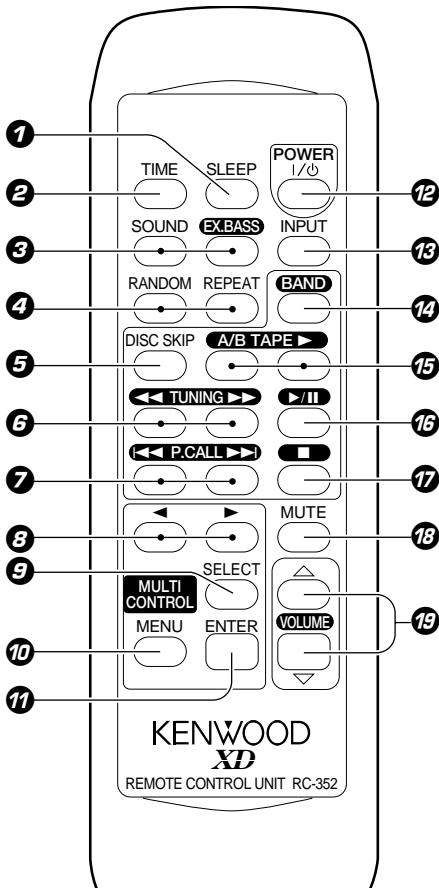

The keys on the remote control unit with the same names as on the main unit have the same function as the keys on the main unit.

- 1 SLEEP key** - 34  
Key for setting the sleep timer
- 2 TIME key** - 17  
Press to switch the time information on the CD player unit.
- 3 SOUND key** - 15  
Switching between FLAT/JAZZ/POP/ROCK
- 4 EX.BASS key** - 15  
Used for CD random playback.
- 5 RANDOM key** - 21  
Used for CD repeat playback.
- 6 REPEAT key** - 20
- 7 DISC SKIP key** - 17
- 8 TUNING (◀▶) keys** - 17 - 22  
Used for reception frequency tuning and as CD search keys.
- 9 P.CALL (◀▶) keys** - 18 - 22  
Used to call preset broadcasting stations and as CD skip keys.
- 10 MULTI CONTROL keys** - 15  
The left and right keys have the same functions as the **MULTI CONTROL** jog dial on the main unit.
- 11 SELECT key** - 15
- 12 MENU key** - 15
- 13 ENTER key** - 15
- 14 POWER (I/O) key** - 14  
Power ON/OFF switching is executed.
- 15 INPUT key** - 14
- 16 BAND key** - 22
- 17 TAPE A/B key** - 24  
Tape playback (▶) key
- 18 (CD) Play/pause (▶/||) key** - 16
- 19 Stop (■) key** - 16
- 20 MUTE key** - 15  
Used for temporary muting
- 21 VOLUME key** - 14

## Loading batteries

**1 Remove the cover.**

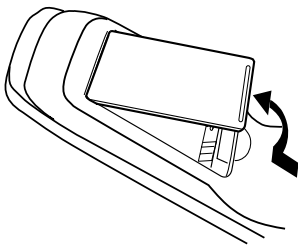

**2 Insert batteries.**

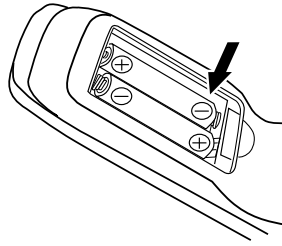

**3 Close the cover.**

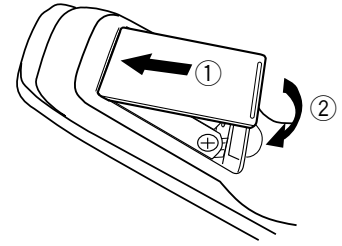

● Insert two R6 ("AA"-size) batteries following the polarity indications.

## Operation

Plug the power cord into the mains power outlet and press the on/standby (I/O POWER) key of the remote control unit to turn power ON. After the power has been turned ON, press the desired key.

To turn power off, press the on/standby (I/O POWER) key again.

● When pressing more than one remote control keys successively, press the keys securely by leaving an interval of 1 second or more between keys.

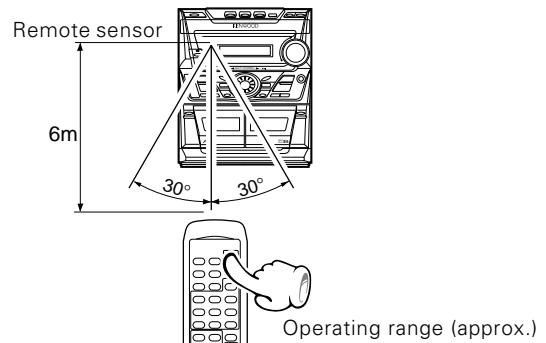

1. The provided batteries are intended for use in operation checking, and their service life may be short.
2. When the remote controllable distance becomes short, replace both of the batteries with new ones.
3. If direct sunlight or the light of a high-frequency fluorescent lamp (inverter type, etc.) is incident to the remote sensor, malfunction may occur. In such a case, change the installation position to avoid malfunction.

This unit incorporates a clock function. Be sure to adjust the correct time before using the timer function. The time is displayed only while the power is off.

## 1 Switching the power ON.

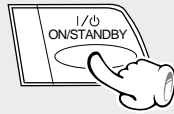

## 2 Select "Clock Options".

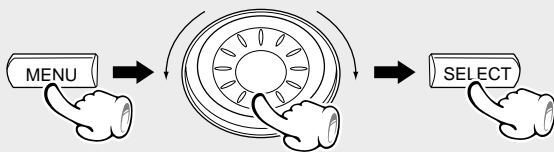

## 3 Select "Adjust Time".

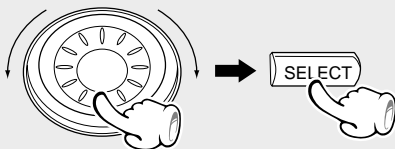

## 4 Enter the figure of hour.

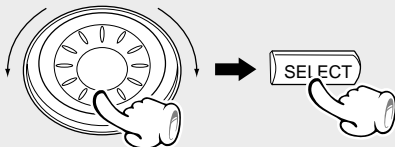

To decrease the figure

To increase the figure

## 5 Enter the figure of minute.

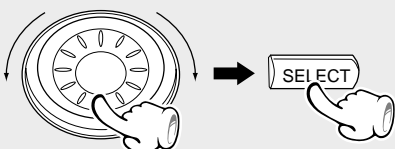

To decrease the figure

To increase the figure

The following items can be selected by turning the MULTI CONTROL jog dial.

- ["CD Program Play"]
- ["Recording Options"]
- ["Sound Options"]
- ["Clock Options"]**

- The display contents change according to the operation mode.

← Scrolled display (Clock Options)

Clock Opti

The following items can be selected by turning the MULTI CONTROL jog dial.

- ["Sleep Time"]
- ["Adjust Time"]**
- ["Timer"]

Example: Adjustment to 8:45



AM12 ↔ AM1 ↔ AM2...  
PM1 ↔ PM2... ↔ AM12 ...

- The time display starts to blink.
- Press the **SELECT** key. The hour is entered and the minute display starts to blink.



00 ↔ 01 ↔ 02...59 ↔ 00 ↔ 01...

- By turning the Jog dial and displaying "Return," you can return to the previous step and do a procedure over again.
- To adjust correct time, press the **ENTER** key at the same moment as a time announcement.

# Basic use method

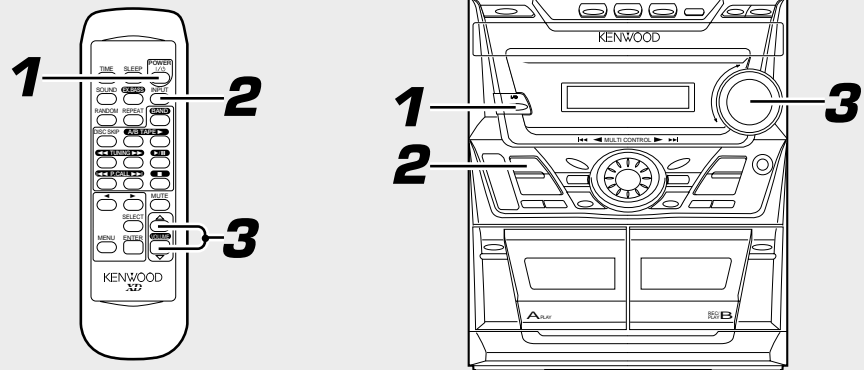

Operation

## 1. Switching the power ON

If a disc has already been loaded in the CD player and the power is OFF, simply pressing the CD play key turns power automatically ON and starts playback.

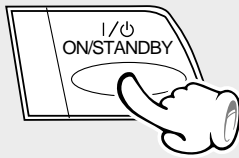

## 2. Selecting the desired output

- ① TUNER (Radio) - 22
- ② CD - 16
- ③ TAPE - 24
- ④ AUX (External input) - 9

When CD has been selected.

CD01 0:00

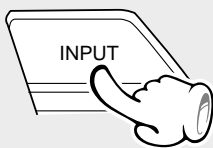

## 3. Volume adjustment

To increase volume

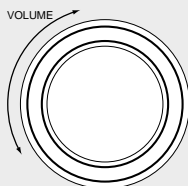

To decrease volume

Volume display

Volume 19

**Muting the sound temporarily (Remote control unit only)**

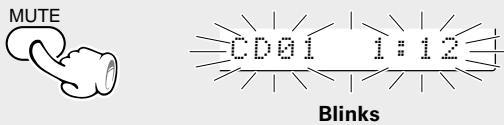

- Press again to resume the original volume.
- The sound muting is also canceled when the volume is controlled.

**Listening through headphones**

Insert the headphone plug into the PHONES jack.

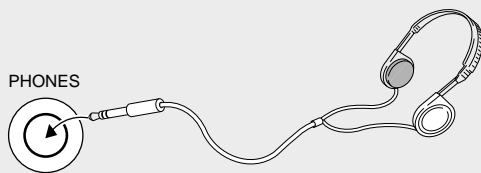

- The sounds from all speakers are cut off.

**STANDBY mode of ON/STANDBY ( | / ⏻ ) switch**

When the power cable plug of this unit is inserted into a receptacle, a minute current flows for memory protection. This status is referred to as the STANDBY mode, and the unit in the STANDBY mode can be turned ON from the remote control unit.

**One-touch operation function**

The power can also be turned ON by pressing the play key of the CD player, the play key of the cassette deck or the BAND key of the tuner.

It is also possible to turn the power ON by simply pressing the OPEN/CLOSE ( ▲ ) Key.

- When the CD or TAPE input is selected and a disc has been loaded in the disc tray or a tape has been loaded in the deck for use in playback, playback starts at the same time.

**Changing the Tone (Selecting the equalizer pattern )**

Select the desired pattern according to the category of the played music.

- EX.BASS will be canceled when an Equalizer pattern is set.

**1 Select the "Sound Options"**

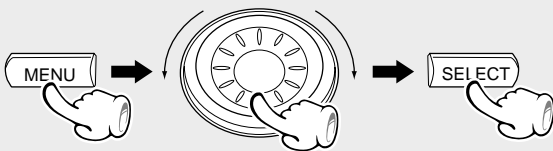

**2 Select the desired equalizer pattern.**

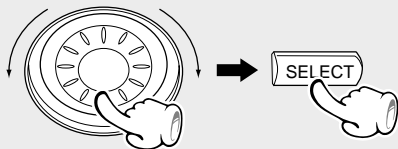

- Lit
- “Rock” ..... Rock music
  - “Pop” ..... Pop music
  - “Classic” ... Classic music
  - “Jazz” ..... Jazz music
  - “Flat” ..... Normal playback

**Changing the Tone (Selecting the bass boost )**

- The factory setting is ON.
- The Equalizer setting will be canceled when EX.BASS is ON

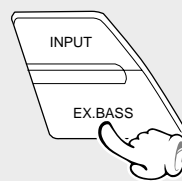

Each press of the key switches the mode as follows

- “EX.BASS on” .... Extra Bass on
- “EX.BASS off” .... Cancel



**Switching the sound level meter display mode**



Each press switches the modes as follows.

- “Display Auto”
- “Display 1”
- “Display 2”
- “Display 3”



This part changes in 3 stages, depending on the display mode.

- When “Display Auto” is selected, the display mode during CD playback changes to “Display 1”, “Display 2” and “Display 3” every time the track changes.
- “Display 3” is displayed regardless of the current music signal.

**Remote control**

Each press of the key switches the mode as follows



- “Rock” ..... Rock music
- “Pop” ..... Pop music
- “Classic” ... Classic music
- “Jazz” ..... Jazz music
- “Flat” ..... Normal playback

## Sequential playback from the first track



If a disc has already been loaded in the CD player and the power is OFF, simply pressing the CD play key turns power automatically ON and starts playback.

High-speed search in forward and reverse directions

Skipping tracks

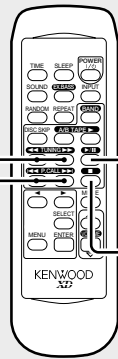

**2**  
To Playback/  
To pause Playback  
To stop Playback

DISC SKIP

To stop Playback

**1**

**2**  
To Playback/  
To pause Playback

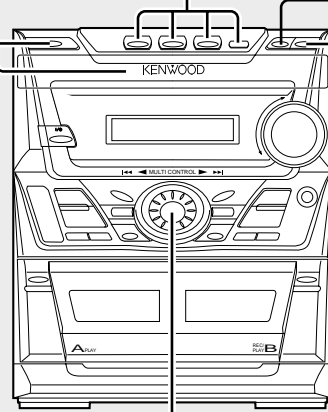

Skipping tracks

Operation

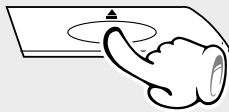

The tray opens when the key is pressed and closes when the key is pressed again.

### 1. Load a disc.

- 1 Open the tray.
- 2 Place a disc.
- 3 Close the tray.

Disc played first when the ►/|| key is pressed.

The label must be on top.

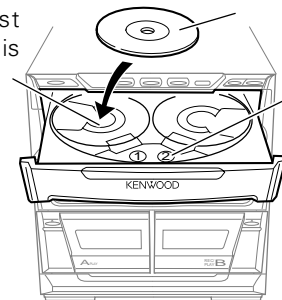

### 2. Start playback.

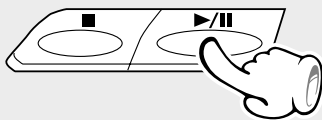

- After a few seconds, play starts from track No.1.
- Playback stops after having played all discs in the trays. (Relay play)
- When the OPEN/CLOSE (▲) key is pressed during playback, the tray opens but the playback continues. (The **DISC SKIP** key is inoperative at this time.)

#### To pause playback

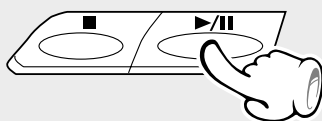

- Each press pauses and plays the CD alternately.

#### To stop playback





# Playback from the desired track

## Skipping tracks

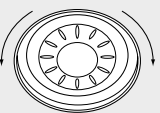

**To skip backward**      **To skip forward**

- The tracks in the direction the dial is rotated are skipped, and the selected track will be played from the beginning.
- When the jog dial is rotated a little in the direction of counterclockwise once during playback, the track being played will be played from the beginning.
- The CD tracks can also be skipped using the ◀◀ or ▶▶ key of the remote control unit.

## High-speed search in forward and reverse directions (Remote control unit only)

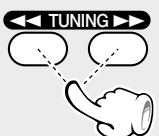

**Backward search**      **Forward search**

- Playback starts from the position where the key is released.

## Skipping to a Different Disc

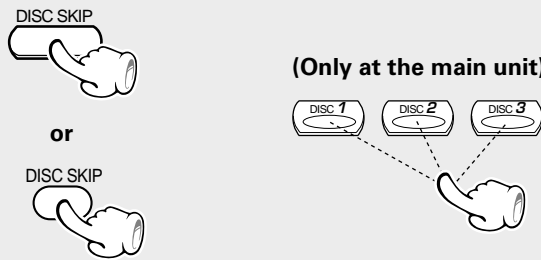

**(Only at the main unit)**

- Each time this key is pressed, the unit skips to the next disc and playback starts.
- When no disc is set in a tray, the unit skips to the next tray.
- Playback starts from the selected disc.
- When no disc is set in a tray, the unit skips to the next tray.

- Do not touch the played side of disc.
- Rotate the tray with the **DISC SKIP** key to insert the third disc.

The selected disc is indicated.

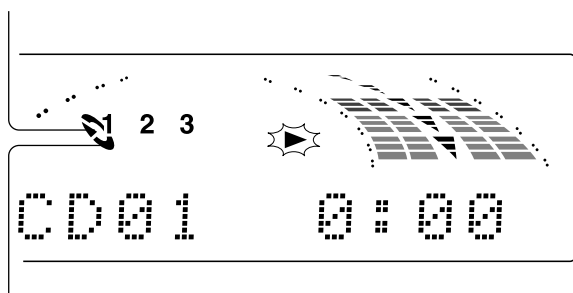

Lights when a disc is inserted at the time of playback.

## Time display on the CD player

Each press of the **TIME** key of the remote control unit switches the displayed time information.

- ① @ : 12 Elapsed time of track being played
- ② -4 : 18 Remaining time of track being played
- ③ 12 : 46 Elapsed time of disc ("TOTAL" lights up)
- ④ -63 : 14 Remaining time of disc ("TOTAL" lights up)

- Only the elapsed time of the track being played is displayed during program playback and random playback.

## Caution for Disc Handling

Do not use a disc with exposed adhesive from attached cellophane or a rental CD seal, or from which such a seal etc. has been removed. When such a disc is played, removal may become impossible, and trouble can be caused.



## CAUTION

**Do not look into the laser light.**

Laser light getting into your eyes can impair your vision.

## Listening in the desired sequence (program playback)

Any titles on the discs in the tray can be listened to in the desired sequence. (Max. 32 titles)

Select the "CD" input.

### 1 Check that the CD player is in the stop mode.

If it is in play mode



### 2 Select "CD Program Play".

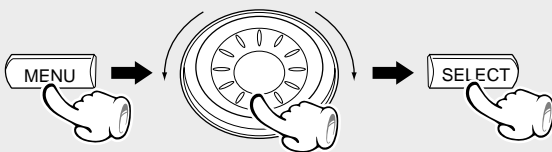

### 3 Enter track No.s in the order you want to play them.

#### 1 Select the disc.

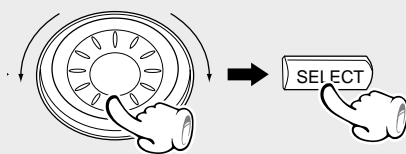

#### 2 Select the track.

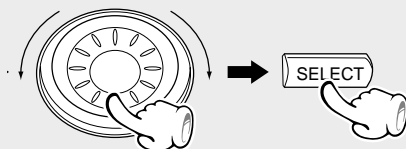

(To select other tracks, repeat steps 1 and 2 for each of the additional tracks.)

#### 3 Press the ENTER key.



(Go to step 2 if you do not need to check the program contents.)

- If the operation in step 2 is performed during playback of a track, the current track can be programmed as the first track in the program.

The following items can be selected by turning the MULTI CONTROL jog dial.

"CD Program Play"  
("Recording Options")  
"Sound Options"  
"Clock Options"

←Scrolled display (CD Program Play)

CD Program

←Scrolled display (Select Disc/Track No.)

Select Dis

P01 D1 T01

P01 D1 T01

Lights

PGM

- Even if you program a disc or track which does not exist in the tray, it is deleted automatically in playback.
- By turning the Jog dial and displaying "Return," you can return to the previous step and do a procedure over again.
- Up to 32 tracks can be programmed. When "Full" is displayed, no more tracks can be programmed.

←Scrolled display

(Press 'ENTER' to Start, 'JOG' to Check )

Press 'ENT

#### 4 Check the programmed tracks (and replace, add or delete tracks as required).

To check:

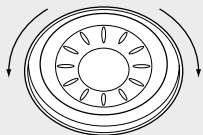

#### To replace a track in the program:

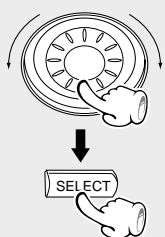

- 1 Select the programmed disc or track to be replaced and press the SELECT key.
- 2 Select a disc or track to replace the disc or track selected above (step 3-1 and 2).

#### To add a track to the program:

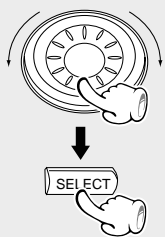

- 1 Select the display as shown on the right and press the SELECT key.
- 2 Perform the same operations as in step 3-1 and 2.

#### To delete a track from the program:

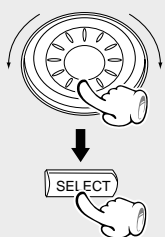

- 1 Select the programmed disc or track to be cleared and press the SELECT key.
- 2 Select "clear" and press the SELECT key.

#### 5 Enter it.



(Playback starts from the first programmed track (program No. 1))

- Turn the **MULTI CONTROL** jog dial during program playback to the previous or next programmed track.
- When the jog dial is rotated a little in the direction of counterclockwise once during playback, the track being played will be played from the beginning.
- To check (modify, add or delete) the programmed tracks after playback, perform the operations in steps 2 and 4.

Press the TIME key on the remote control unit to switch the time display.

P01 D1 T02

- The programmed tracks are displayed in sequence.

P12 D3 T04

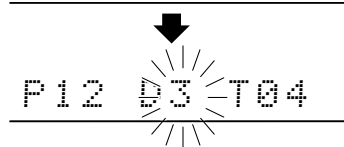

- The blinking item can be replaced.

P-- D- T--

- The added track number is added to the end of the existing program.

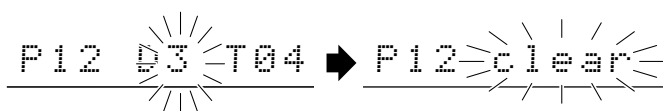

#### To quit the program mode

- 1 Select "CD Program Play".

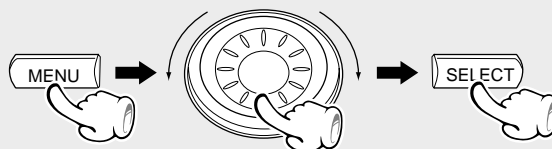

- 2 Press the MENU key.



Goes off  
PGM

- If the key is pressed during playback, normal playback in order of tracks resumes from the current track.
- The program mode can also be canceled by pressing the ▲ key.

# Repeated playback

Desired titles or discs can be played back repeatedly.

Select the "CD" input.

To repeat only one track

To repeat a disc

To repeat all discs

## 1 Cancel "PGM".

If the "PGM" indicator is lit, make sure to turn it off.



Goes off



## 2 Select the disc.



## 3 Select the track.

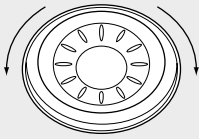

## 4 Select repeat mode.

(Remote control unit only)



Press the key repeatedly to switch the display.

- ① "Repeat"  
When "One Track Repeat" is selected during playback, the track being played back will be repeated.
- ② "Disc Repeat"
- ③ "All Repeat"
- ④ Repeat canceled

Repeat

Lit



To repeat only the programmed tracks

## 1 Perform the procedure in "Listening in the desired sequence (program playback)" till step 3 to program the desired CD tracks.



Lit



- All of the programmed tracks will be played repeatedly.

## 2 Start playback.



## 3 Select "All Repeat"

(Remote control unit only)

REPEAT



Press the key repeatedly to switch the display.

- ① "All Repeat"
- ② Repeat canceled

← Scrolled display (PGM Repeat)

All Repeat

Lit



To stop repeated playback

Press the REPEAT key repeatedly until the repeat mode is switched off.

- The repeat mode can also be canceled by pressing the ▲ key.

# Random playback

As the titles each time are selected randomly, the music can be enjoyed without getting tired of it. Random playback can play tracks in one to three discs.

Select the "CD" input.

## 1 Cancel "PGM".

Goes off  
 If the "PGM" indicator is lit, make sure to turn it off. → 19

## 2 Select the RANDOM mode.

(For "Disc Random" playback, select the disc in advance.)

(Remote control unit only)



Press the key repeatedly to switch the display.

- ① "Disc Random"  
Random play of one disc
- ② "All Random"  
Random play of all discs
- ③ "Random off" (Normal playback)

### Random play of one disc

←Scrolled display (One Disc Random)



- Playback stops after each disc has been played once.

### Random play of all discs

←Scrolled display (All Disc Random)



- Playback stops after each title has been played once.

- When the **TIME** key of the remote control unit is pressed during playback, the time display appears but it soon returns to the original display.

## To select another track in the middle of playing one

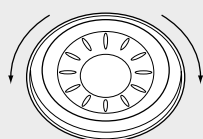

- When the jog dial is rotated a little in the direction of counterclockwise once during playback, the track being played will be played from the beginning.

## To repeat random playback

Select "Random Repeat" during random playback.

(Remote control unit only)

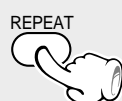

Each press switches the modes as follows.

- ① "Random Repeat" ..... Random repeat mode
- ② Random Repeat canceled

## To cancel random playback

Select "Random off".

(Remote control unit only)



- The random mode can also be canceled by pressing the **▲** key. Normal playback in order of track numbers starts from the track being played.

It is also possible to receive them by one-touch operations by storing up to 30 stations in the preset memory.



When the BAND key is pressed, this unit will be switched on automatically.

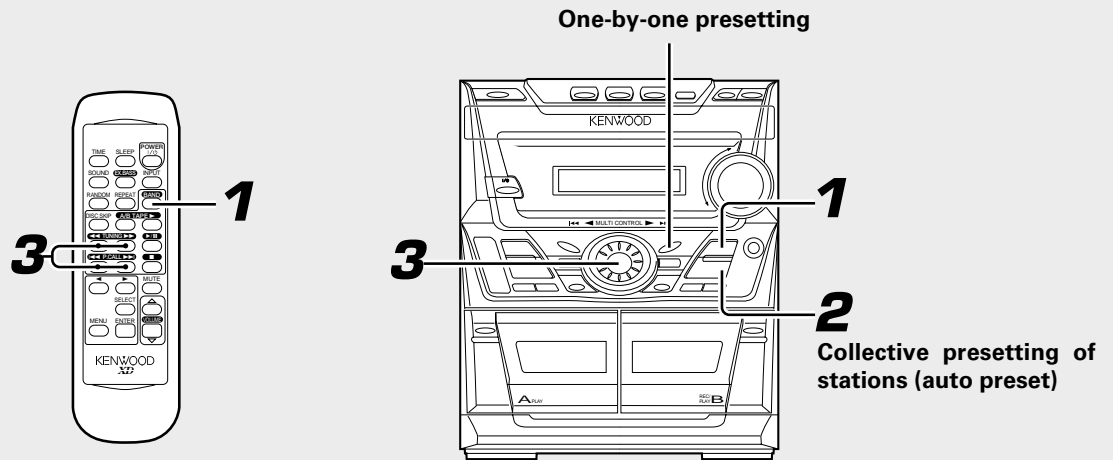

### 1. Select the broadcast band.

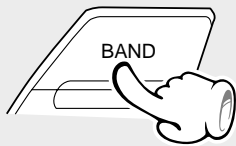

Each press changes the band.

- |  |    |   |    |   |
|--|----|---|----|---|
| <ul style="list-style-type: none"> <li>① FM</li> <li>② AM</li> </ul> | or | <ul style="list-style-type: none"> <li>① FM</li> <li>② MW (AM)</li> <li>③ LW</li> </ul> | or | <ul style="list-style-type: none"> <li>① FM</li> <li>② MW (AM)</li> <li>③ SW</li> </ul> |
|--|----|---|----|---|

### 2. Selecting the tuning mode

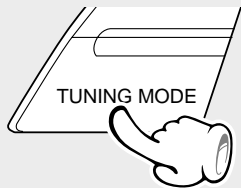

Each press alternates the mode.

- “Auto” (Auto tuning)
- “P.call” (Preset call)
- “Manual” (Manual tuning)

- When no operation has been performed for 5 seconds while “P.call” is displayed, the tuning mode is set automatically to “AUTO”.

### 3. Select a station.

#### When no stations have been memorized

- Auto tuning** : Turn the **MULTI CONTROL** jog dial to receive the next tuned station automatically.  
(On the remote control unit, press the ◀◀ or ▶▶ key.)
- Manual tuning** : Turn the **MULTI CONTROL** jog dial to select a station.  
(On the remote control unit, press the ◀◀ or ▶▶ key.)

#### When stations have been memorized (Preset call)

Turn the **MULTI CONTROL** jog dial to select a station.  
(On the remote control unit, press the ◀◀ or ▶▶ key.)

- When a key is held depressed, preset stations will be skipped at an interval of about 0.2 second.

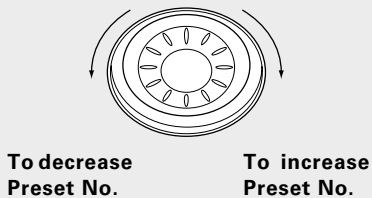
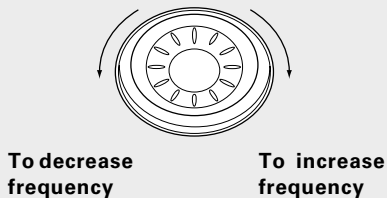

## Collective presetting of stations (auto preset)

Keep the TUNING MODE key depressed  
(about 2 seconds).



- Some stations may not be able to be preset if their reception conditions are weak.
- A maximum of 30 stations are preset automatically by giving the priority to the FM band.
- When there are many stations and the intended station has not been preset, please also use **“One-by-one presetting (manual preset)”**.
- The stations which have been preset are overwritten.

## One-by-one presetting (manual preset)

① Press the ENTER key during reception.



Presetting is cancelled when no operation is executed for 5 seconds or more.

② Select one of the preset numbers from 1 to 30 during “Memory” is display.

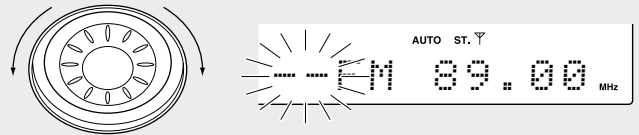

Presetting is cancelled when no operation is executed for 5 seconds or more.

③ Press the ENTER key again.



- Repeat steps ①②③ to preset other stations.
- If several stations are preset under the same number, the previous memory is replaced with the latest memory contents.

- Use the manual tuning mode when reception is noisy due to weak reception. (In the manual mode, stereo broadcasts are received in monaural.)
- Normally, use the **“AUTO”** (Auto tuning) mode.
- If you are operating the remote control unit, the **“AUTO”** (Auto tuning) and manual tuning mode can be alternated by pressing the stop (■) key.

Lights during stereo reception

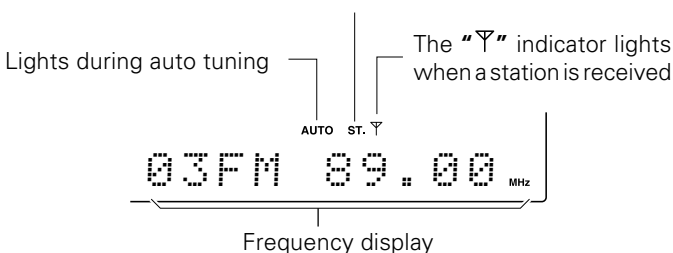



By loading a tape in the cassette deck to be used in playback beforehand, simply pressing the play key automatically turns the power ON and starts playback.

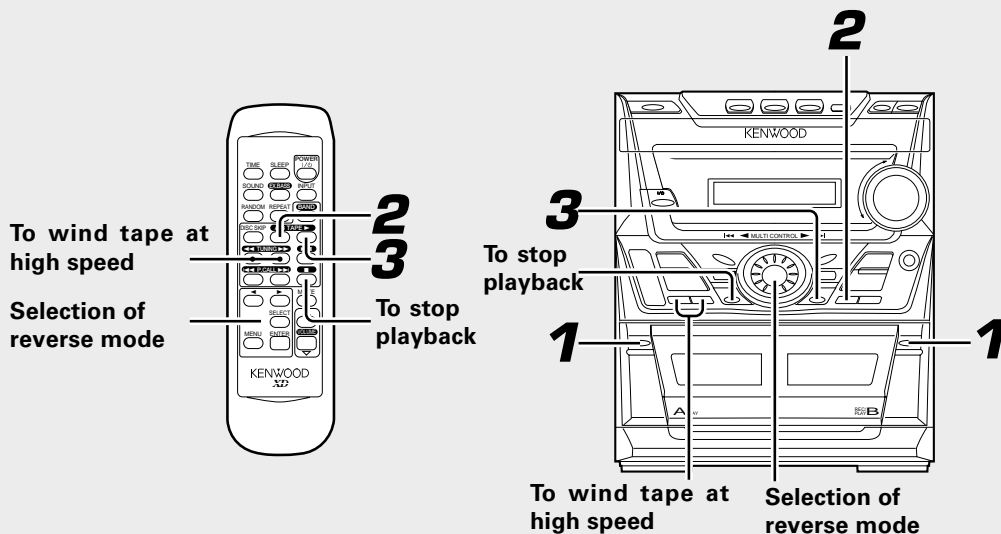

### 1. Load a cassette tape.

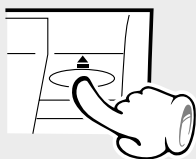

- ① Open the door.
- ② Insert a tape and close the door.

- Remove tape slack before loading.
- Close the door securely.

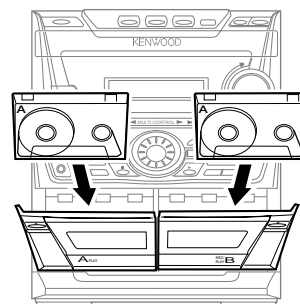

### 2. Select the deck to be used for playback.

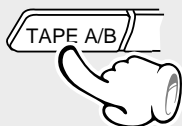

### 3. Start playback.

To change the Tape B running direction, press the ► key again during playback.

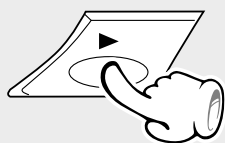



### To wind tape at high speed

To fast wind in direction ←      To fast wind in direction →

- Press the ■ key to stop fast winding.

### To stop playback

- Do not take out the cassette tape until the tape transport has stopped completely.

### Caution for cassette tape ejection

- Do not attempt to eject the cassette tape until the tape has been stopped completely by pressing the stop (■) key. Opening the cassette holder while the mechanism is running may lead to malfunction. Should it become impossible to close the cassette holder, turn power off then on again.

### Selection of reverse mode

- 1 Select the "Tape Options".
- 2 Select the "Reverse Mode".
- 3 Select desired mode.

- ① "←" ..... Playback stops after having played one side of tape.
- ② "↔" ..... Playback stops after having played both sides of tape in a deck.
- ③ "↻" ..... Endless playback of both sides of tape.

### Relay play

When a tape is inserted in both deck A and deck B, Relay Playback is possible and tape B playback will start when tape A playback is over.

- 1 Insert a tape in both deck A and deck B.
- 2 Select tape B Reverse mode.
- 3 Start tape A playback.

When tape A playback is over, tape B playback will start in the right arrow (>) direction, in accordance with the Reverse mode setting.

Reverse mode indication.

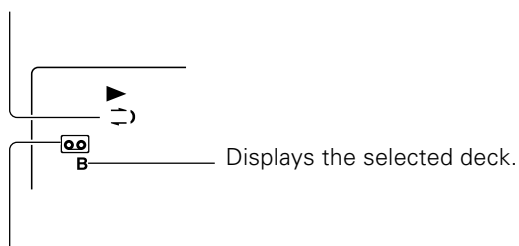

Lights up when a tape is present in the deck in use.

### Transport direction indicators

The indicators (←, →) indicate the current direction in which the tape advances when playback or recording is started automatically by the one-touch operation function, etc. This direction is the direction stored in memory when the tape was last stopped.

Whenever you put in or take out a tape, the tape will always run in the → direction. (To change the tape running direction, press the → key, and after playback has started, press the → key again and then press the ■ key.)

Tape direction indicators of currently selected deck.

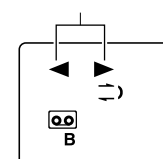

# Recording on TAPE

This unit cannot record on a high-position (Type II) tape or metal tape.

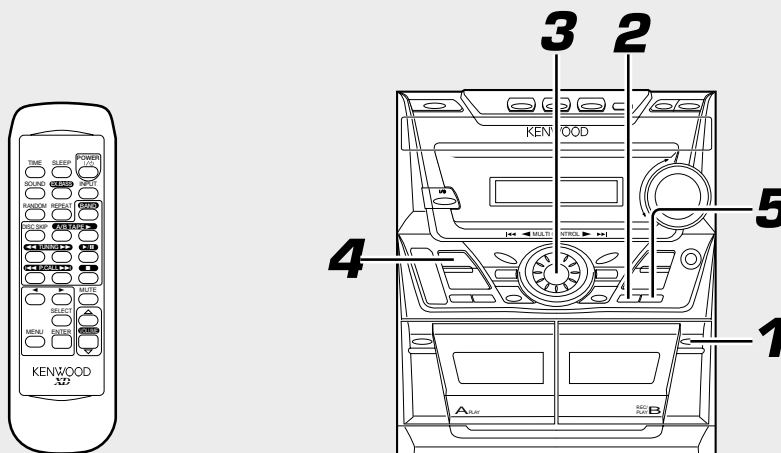

Operation

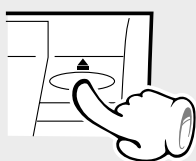

### 1. Load a cassette tape. (Recording is available on deck B only.)

- ❶ Open the door of deck B.
- ❷ Insert a tape and close the door.

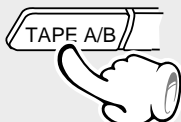
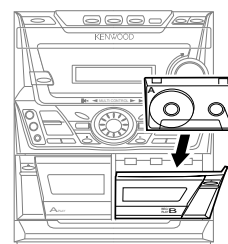

### 2. Select the tape transport direction.

To reverse the transport direction

- ❶ Select deck B by pressing the A/B key.
- ❷ To change the Tape B running direction, press the ► key again during playback.
- ❸ Stop playback (by pressing the ■ key).

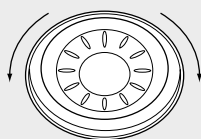
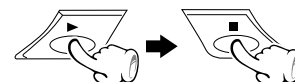

### 3. Set the recording condition.

Select the reverse mode.

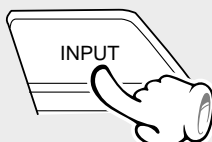

### 4. Select the source to be recorded.

- ❶ TUNER (Radio)
- ❷ CD
- ❸ TAPE (This source cannot be recorded.)
- ❹ AUX (External input)

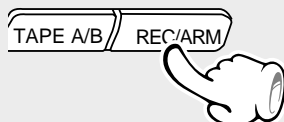

### 5. Start recording.

- ❶ Start recording.
- ❷ Play (or tune) the input source to be recorded.

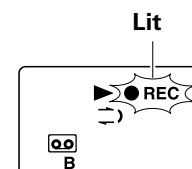

## To pause recording (Main unit only)

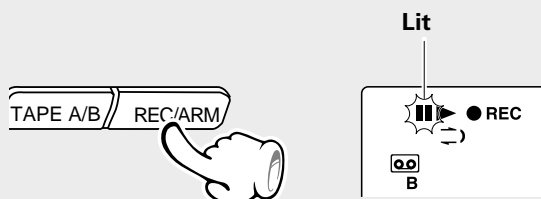

- Pressing the key pauses recording after leaving a non-recorded space of about 4 seconds.
- If the key is pressed again in less than 4 seconds after it has been pressed, recording resumes from that instant.

## Selection of reverse mode

- 1 Select the "Tape Options".

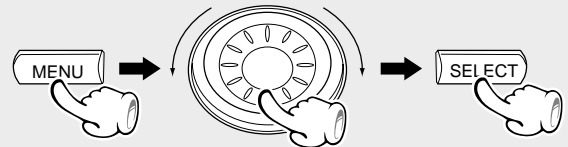

- 2 Select the "Reverse Mode".

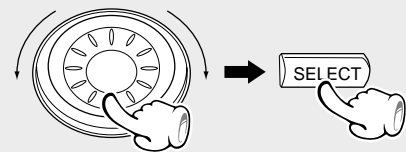

- 3 Select desired mode.

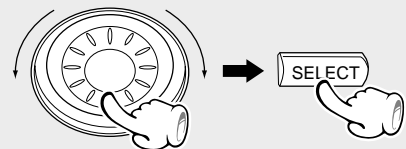

- ① "←" ..... Recording stops after having recorded one side of tape.
- ② "↔" ..... Recording stops after having recorded both sides of tape.
- ③ "↔" ..... Recording stops after having recorded both sides of tape.

- When the "←" transport direction indicator is lit, recording always stops after having recorded one side of tape.

- This unit cannot record on a high-position (Type II) tape or metal tape.
- Remove tape slack before loading.

- When recording is started, the tape is transported in the direction selected in this step.
- Wind the tape to the position where recording is to be started.

Check the tape transport direction indicator. → 25

## When Recording from a CD

The unit is equipped with handy functions for recording from a CD. For details, refer to page 29.

## Beat cancel function

There may be cases in which beat noise interferes with recording of AM (MW)/LW broadcasting. Switch to "Beat Cancel" before recording the program you want to record. Make a trial recording and then record where the transmission noise is lowest.

- 1 Start recording an AM broadcast.
- 2 Press the Tape A/B key.
  - ① "Beat Cansel on"
  - ② "Beat Cansel off"
- 3 Listen to the sound on the trial recording and select the best sound.



CD01 1:12

The input source component to be recorded should be displayed.

- If a disc has already been loaded when the CD input is selected, it will start to play automatically. In this case, press the stop (■) key to stop it.
- Even if deck A is selected, it is automatically switched to deck B at the start of recording.
- Recording stops automatically when the tape side(s) to be recorded have been fully recorded.
- Press the stop (■) key of the cassette deck unit to stop recording.

# Copying tape (Tape dubbing)

The contents of the tape in deck A can be copied onto the tape in deck B.

## Load tapes in the decks.

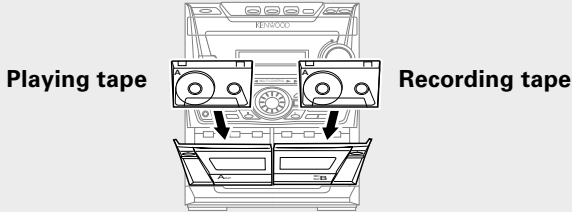

### 1 Select the "TAPE" input.

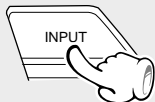

### 2 Press the stop key.

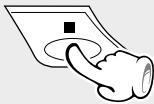

### 3 Select "↔" (double-side recording) or "→" (one-side recording).

→ 27

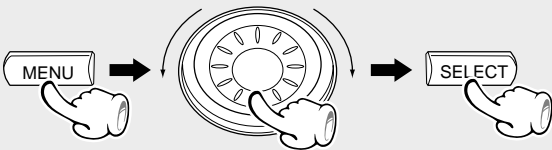

### 4 Select "Tape Options".

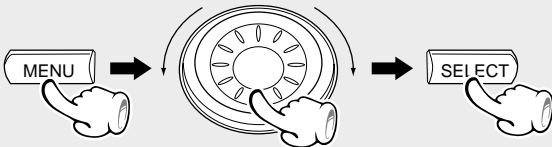

### 5 Select "Tape Dubbing".

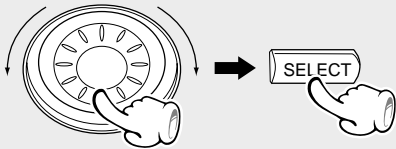

← Scrolled display (Tape Dubbing)

Tape Dubbi

### 6 Use the same tape transport directions.

- When recording is started, the tape will be transported in the direction selected in this step.

(▶ : side A, ◀ : side B)

### Select the transport direction of deck B.

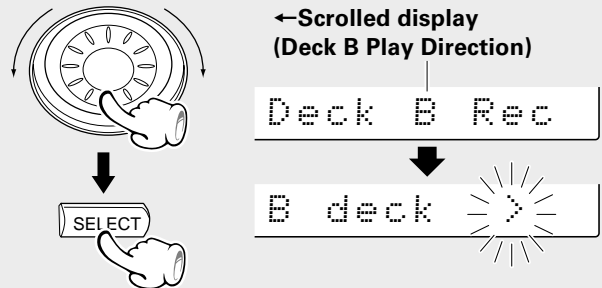

### 7 Start dubbing.

← Scrolled display (Press 'ENTER' to Start)

Press 'ENT



- Dubbing ends automatically when the side(s) to be dubbed has been completed.

## To stop dubbing



- press the stop (■) key.

The tape recorded on deck B assumes the same Dolby NR condition as the tape played on deck A.

## Selection of the Recording Type

With this unit, the following edit recording is possible according to the purpose.



This unit cannot record on a high-position (Type II) tape or metal tape.

### If you want to select the track to be recorded while playing a CD

#### Recording only desired titles

→ 30

#### **CD ONE TRACK RECORDING**



Perform this operation when a track you want to record starts during CD playback. This starts recording of the track from the beginning.

### If you want to record a CD in order of track numbers

#### Recording of an entire CD

→ 31

#### **CD DIRECT RECORDING**



Perform the "CD DIRECT RECORDING" operation while the CD player is in stop mode to start recording.

### If you want to record only the desired tracks

#### Recording the programmed titles

→ 32

#### **CD PROGRAM RECORDING**



Program the desired tracks from up to 3 CD discs in the desired order and record the programmed playback onto tape.



With recording onto tape, the track will be interrupted for the part of the guide tape at the tape reversal, where recording is not possible. Please use single-side recording if this is to be avoided.

## Recording only desired titles (CD ONE TRACK RECORDING)

At the time of CD playback, any desired title can be selected immediately for recording.

Recording preparations are required. →  (Steps 1 to 3)

### 1 Playback of CD.

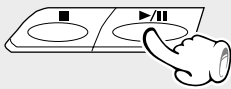

### 2 Select "Recording Options".

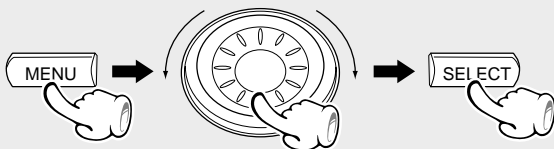

### 3 Select "CD One-Track Recording".

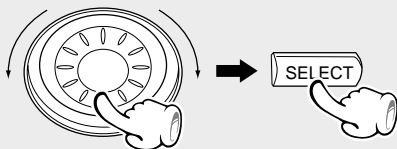

### 4 Start recording.



When recording has been completed, a non-recorded portion of 4 seconds will be produced and the cassette deck part will stop. The CD player will enter temporary stop condition.

To record a different track, repeat the steps 1 to 4.

- Select a mode other than random play.

The following items can be selected by turning the MULTI CONTROL jog dial.

- "CD Program Play"
- "Recording Options"
- "Sound Options"
- "Clock Options"

← Scrolled display (Recording Options)

Recording

The following items can be selected by turning the MULTI CONTROL jog dial.

- "CD One-Track Recording"  
(Only during CD playback)
- "CD Direct Recording"
- "CD Program Recording"

← Scrolled display (CD One Track Recording)

CD One-Track

← Scrolled display (Press 'ENTER' to Start)

Press 'ENT

- Playback restarts from the beginning of the track being played and recording starts at the same time.

### To end recording in the middle



CD STOP key

- Both the cassette deck and CD player stop.

# Recording of an entire CD (CD DIRECT RECORDING)

Perform the following operation while the CD player is in stop mode to start recording at the same time as the start of playback.

Recording preparations are required. → 26 (Steps 1 to 4)

## 1 Check that the CD player is in the stop mode.

If it is in play mode



## 2 Select "Recording Options".

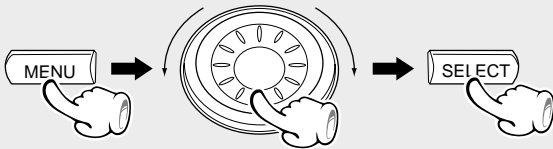

## 3 Select "CD Direct Recording".

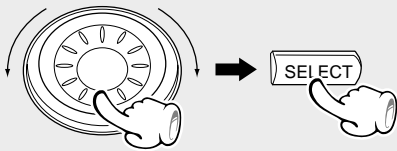

## 4 Select the disc.

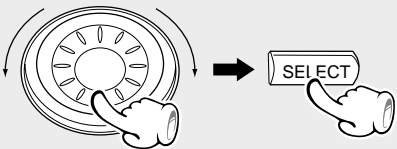

## 5 Start recording.



- Recording of CD starts at the same time as playback.
- At the end of tape, the music is not recorded on the leader tape portion. If you do not want any music to be interrupted in the middle, refer to "Recording on TAPE" and start recording of side B with the interrupted track.

The following items can be selected by turning the MULTI CONTROL jog dial.

- "CD Program Play"
- "Recording Options"
- "Sound Options"
- "Clock Options"

← Scrolled display (Recording Options)

Recording

The following items can be selected by turning the MULTI CONTROL jog dial.

- "CD Direct Recording"
- "CD Program Recording"

← Scrolled display (CD Direct Recording)

CD Direct

← Scrolled display (Select Disc No.)

Select Dis → Disc No. 1

← Scrolled display (Press 'ENTER' to Start)

Press 'ENT

## To end recording in the middle



CD STOP key

- Both the cassette deck and CD player stop.

## Recording the programmed titles (CD PROGRAM RECORDING)

Program the desired tracks from up to 3 CD discs in the desired order and record the programmed playback onto tape.

Recording preparations are required. →  (Steps 1 to 4)

### 1 Check that the CD player is in the stop mode.

If it is in play mode



### 2 Select "Recording Options".

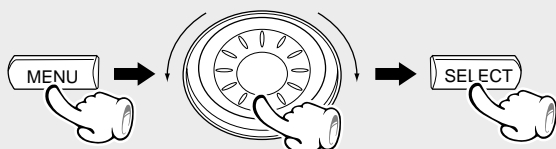

### 3 Select "CD Program Recording".

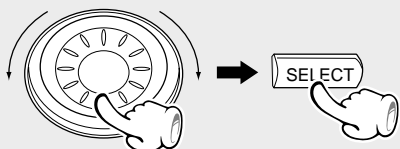

### 4 Program the desired tracks.

- ① Select tracks in the order you want to play them. (Perform step 2 on page 18.)
- ② Check, replace, add or delete the programmed tracks as required. (Perform step 4 on page 19.)

### 5 Start recording.



The following items can be selected by turning the MULTI CONTROL jog dial.

- ← "CD Program Play"
- ← "Recording Options"
- ← "Saund Options"
- ← "Clock Options"

← Scrolled display (Recording Options)

Recording

The following items can be selected by turning the MULTI CONTROL jog dial.

- ← "CD Direct Recording"
- ← "CD Program Recording"

← Scrolled display (CD Program Recording)

CD Program

← Scrolled display  
(Press 'ENTER' to Start, 'JOG' to Check)

Press 'ENT



- The program mode is maintained even after completion of recording. To return to the normal mode, it is required to cancel the program mode.

## To end recording in the middle



- Both the cassette deck and CD player stop.





**Sleep timer (SLEEP)**

The power is turned OFF automatically after the specified period has elapsed.

**Timer programming**

**Timer playback :** Plays (or receives) the selected source in the set time range.

**Timer recording :** Records the selected source in the set time range.

Adjust the clock before setting the timer.



**Sleep timer (SLEEP)**

Set the number of minutes after which the power is to be turned OFF.

Operation

**1 Select "Clock Options".**

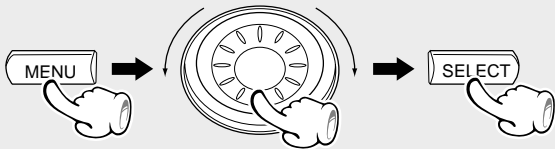

**2 Select "Sleep Timer".**

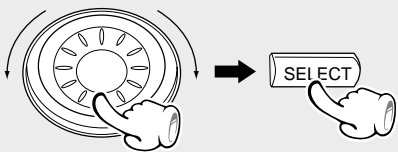

**3 Set the time**

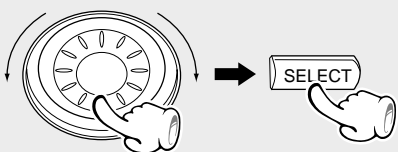

The following items can be selected by turning the MULTI CONTROL jog dial.

- ["CD Program Play"]
- ["Recording Options"]
- ["Tape Dubbing"]
- ["Sound Options"]
- ["Clock Options"]**

← Scrolled display (Clock Options)



The following items can be selected by turning the MULTI CONTROL jog dial.

- ["Sleep Timer"]**
- ["Adjust Time"]
- ["Timer"]

Lit



Blinks



→ 20 ↔ 30...80 ↔ 90 ↔ Return ↔ Sleep off ↔ 10 ←

- The displayed time changes in 10-minute steps. The maximum time that can be set is 90 minutes.
- The power is turned OFF automatically after the set time has elapsed.
- To cancel the sleep timer, turn the power off or select "Sleep off".

## Timer programming

The Program Timer has Timer Playback and Timer Record functions.

Also, "Everyday" or "One-Time" operation can be selected. Preselect an operating time range and contents and then select whether to operate the program or not as necessity demands.

- **If you made a mistake during timer setting:**

By turning the Jog dial and displaying "Return," you can return to the previous step and do a procedure over again.

### Adjust the clock before setting the timer.



## 1 Make preparations for the play (recording).

### To listen to radio

The station should be preset prior to the above. → 23

### To listen to CD

Insert a disc. (Program playback is not possible.)  
Select the disc to be played (1, 2 or 3). → 16 → 17

### To listen to tape

Set a tape in the deck you want to play back the tape. → 24

### Playing or recording the auxiliary input source

Make timer setting of the component connected to the AUX INPUT jacks.

### For recording

Make preparations for recording. → 26

## 2 Adjust the listening volume.

## 3 Select the timer operation.

### 1 Select "Clock Options".

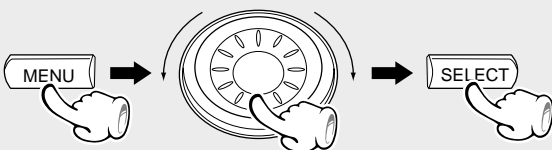

### 2 Select "Timer".

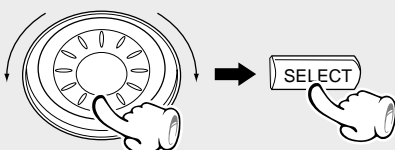

Lit

PROG.

- When the timer function is used for timer recording of an input source, the speakers do not output the audio even after the unit is turned on by the timer.

The following items can be selected by turning the MULTI CONTROL jog dial.

- ("CD Program Play")
- ("Recording Options")
- ("Tape Dubbing")
- "Sound Options"
- "Clock Options"

The following items can be selected by turning the MULTI CONTROL jog dial.

- "Sleep Timer"
- "Adjust Time"
- "Timer Play"

Continued on next page...

**4 Select "Everyday" or "One Time".**

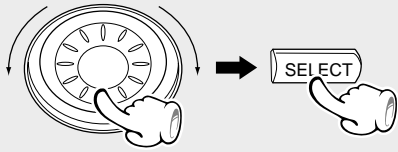

The reservation contents cannot be cleared. The contents are cleared only when they are changed.

**5 Enter the ON time.**

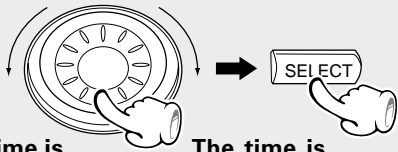

The time is returned.

The time is advanced.

**6 Enter the OFF time.**

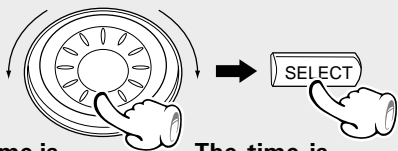

The time is returned.

The time is advanced.

**7 Make the desired reservation.**

**1 Select the mode.**

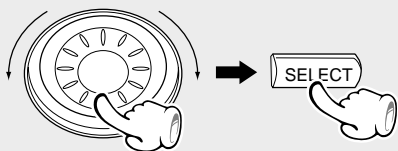

**2 Select the input source.**

**For timer playback**

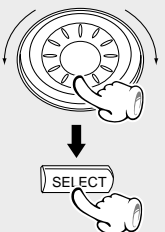

Select the source to be played.

- ① TUNER..... Radio
- ② CD
- ③ TAPE
- ④ AUX ..... External input

**3 Select the broadcast station (only when TUNER is selected above).**

Select the preset station No.

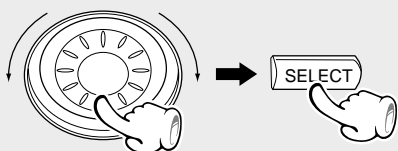

The following items can be selected by turning the MULTI CONTROL jog dial.

- ↳ "Timer off" (Canceled)
- ↳ "Everyday"
- ↳ "One Time"

- To cancel a timer operation, select "Timer off".

←Scrolled display (Select on time)

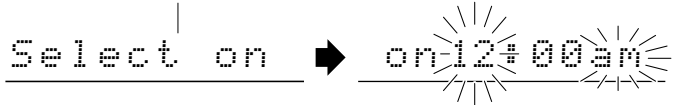

- After entering the "hour", enter the "minute" with the same procedure.

←Scrolled display (Select off time)

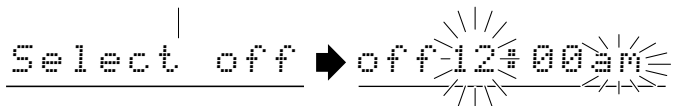

- After entering the "hour", enter the "minute" with the same procedure.

**Select "Timer Play" or "Timer Rec".**

- ↳ ① "Timer Play" ..... Timer play
- ↳ ② "Timer Rec" ..... Timer recording

**For timer recording**

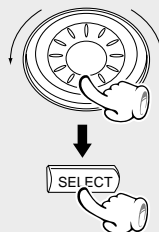

Select the input source.

- ↳ ① TUNER ..... Radio
- ↳ ② AUX ..... External input

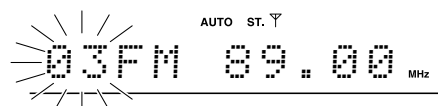

- The set program content items are displayed one after another. ("Everyday" or "One Time" → On time → Off time → Mode → Input source → Preset channel)

**Continued on next page...**

**8** Press the **ENTER** key.



**9** Put the unit in standby mode.



← Scrolled display (Press 'ENTER' to Save)



Lit

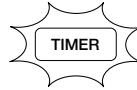

Lit

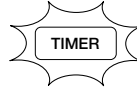

# Maintenance

## Cleaning the head section

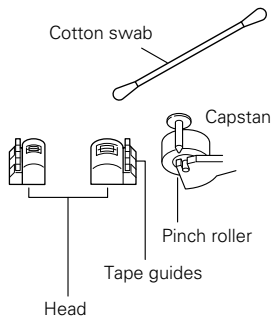

### Cleaning the heads and peripheral components

For maintaining the best condition of the deck and for longer service life, always keep the heads (recording / playback / erase), capstan and pinch roller clean. To clean them, perform the following:

1. Open the cassette holder.
2. Using a cotton swab dipped in alcohol, clean the head (recording / playback / erase), capstan and pinch roller carefully.

### Demagnetizing the head

When the recording / playback head is magnetized, the sound quality will deteriorate. In such a case, demagnetize the head using a commercially available demagnetizer (head eraser).



There are precisely aligned parts around the heads, including the tape guides. When cleaning, pay special attention so as not to apply shock to them.

## Maintenance of the set

When the front panel or case becomes dirty, wipe with a soft, dry cloth. Do not use thinner, benzine, alcohol, etc. for these agents may cause discoloration.

## In regard to contact cleaner

Do not use contact cleaners because it could cause a malfunction. Be specially careful not to use contact cleaners containing oil, for they may deform the plastic component.

## Caution on condensation

Condensation (of dew) may occur inside the unit when there is a great difference in temperature between this unit and the outside. This unit may not function properly if condensation occurs. In this case, leave the unit for a few hours with the power left ON, and restart the operation after the condensation has dried up.

Be specially cautious against condensation in a following circumstance:

When this unit is carried from a place to another across a large difference in temperature, when the humidity in the room where this unit is installed increases, etc.

## Note related to transportation and movement (CD player)

Before transporting or moving this unit, carry out the following operations.

1. Turn the power ON.
2. Unload the discs
3. Close the disc tray.
4. Turn power off.

When your unit needs to be repaired, bring the entire set (Speakers excluded) to your dealer.

What seems to be a malfunction is not always so. Before calling for service, check the following table according to the symptom of your trouble.

## Operation to reset

The microcomputer may fall into malfunction (impossibility to operate, erroneous display, etc.) when the power cord is unplugged while power is ON or due to an external factor. In this case, execute the following procedure to reset the microcomputer and return it to normal condition.





Press the "POWER" key while holding the Stop (■) key of the CD section pressed, to switch off the power, and then switch the power on again after a few seconds.

- Please note that resetting the microcomputer clears the contents stored in and returns and to condition when it left the factory.











## Receiver, speakers

Symptom	Cause	Remedy
Sound is not produced.	<ul style="list-style-type: none"> <li>● The speaker cords are disconnected.</li> <li>● The <b>MUTE</b> switch of remote control unit is switched ON.</li> <li>● The headphone plug is inserted into the jack.</li> </ul>	<ul style="list-style-type: none"> <li>● Connect properly referring to "System connection". → 9</li> <li>● Switch <b>MUTE</b> OFF. → 15</li> <li>● Unplug the headphone plug. → 15</li> </ul>
Sound is not produced from the left or right speakers.	<ul style="list-style-type: none"> <li>● The speaker cords are disconnected.</li> </ul>	<ul style="list-style-type: none"> <li>● Connect properly referring to "System connection". → 9</li> </ul>
Demonstration starts suddenly.	<ul style="list-style-type: none"> <li>● The power plug was unplugged from the outlet while the power switch was ON, or there was a power failure.</li> </ul>	<ul style="list-style-type: none"> <li>● This is not malfunction. Press the <b>DISPLAY/DEMO</b> key to cancel the demonstration. → 4</li> </ul>
The clock display is out of order.	<ul style="list-style-type: none"> <li>● There was a power failure.</li> <li>● The power cord was unplugged from the outlet.</li> </ul>	<ul style="list-style-type: none"> <li>● Adjust the present time again. → 13</li> <li>● Adjust the present time again. → 13</li> </ul>
Timer operation is not possible.	<ul style="list-style-type: none"> <li>● The present time has not been adjusted or there was a power failure.</li> <li>● The timer ON time and OFF time have not been set.</li> <li>● The timer execution was not set up.</li> </ul>	<ul style="list-style-type: none"> <li>● Adjust the present time referring to "Clock adjustment". → 13</li> <li>● Set the timer ON time and OFF time. → 35</li> <li>● Execute the timer program. → 35</li> </ul>
Radio stations cannot be received.	<ul style="list-style-type: none"> <li>● The antennas have not been connected.</li> <li>● A proper broadcasting band has not been selected.</li> <li>● The frequency of the station to be received is not tuned.</li> </ul>	<ul style="list-style-type: none"> <li>● Connect antennas. → 8</li> <li>● Select a band. → 22</li> <li>● Tune to the frequency of the desired station. → 22</li> </ul>
Noise interferes.	<ul style="list-style-type: none"> <li>● Car ignition noise.</li> <li>● Influence of an electric appliance.</li> <li>● A TV set is installed near the system.</li> </ul>	<ul style="list-style-type: none"> <li>● Install the outdoor antenna in an apart position from the road. → 8</li> <li>● Switch the suspected electric appliance OFF.</li> <li>● Install the TV or the system at an increased distance between them.</li> </ul>
A station has been preset but it cannot be received by pressing the PCALL key.	<ul style="list-style-type: none"> <li>● The frequency of the preset station is not tunable.</li> <li>● The preset memory has been cleared because the power cord has been unplugged for a long period.</li> </ul>	<ul style="list-style-type: none"> <li>● Preset stations with tunable frequencies. → 23</li> <li>● Preset stations again. → 23</li> </ul>

**Remote control unit**

Symptom	Cause	Remedy
<b>Remote control operation is not possible.</b>	<ul style="list-style-type: none"> <li>● Batteries are exhausted.</li> <li>● The remote control is too far away from the system, the controlling angle is deviated or there is an obstacle in between.</li> <li>● There is no tape or CD set in the component to be played.</li> </ul>	<ul style="list-style-type: none"> <li>● Replace with new batteries. →  12</li> <li>● Operate the unit inside the remote control-able range. →  12</li> <li>● Set a tape or CD in the component to be played. →  16 →  24</li> </ul>

**Cassette deck**











Symptom	Cause	Remedy
<b>Sound cannot be produced by pressing the play key or no operation occurs even when an operation key is pressed.</b>	<ul style="list-style-type: none"> <li>● The head is dirty.</li> <li>● The tape is wound too tight due to irregular winding.</li> <li>● A nonrecorded tape is played.</li> </ul>	<ul style="list-style-type: none"> <li>● Clean the head referring to "Maintenance". →  38</li> <li>● Try another tape. →  24</li> <li>● Play a recorded tape.</li> </ul>
<b>No operation occurs even when an operation key is pressed.</b>	<ul style="list-style-type: none"> <li>● The cassette holder is not closed completely.</li> <li>● A tape is not inserted in the unit.</li> <li>● The tape is wound too tight due to irregular winding.</li> <li>● The tape is fully wound to one of the reels.</li> </ul>	<ul style="list-style-type: none"> <li>● Close the holder completely. →  24</li> <li>● Insert a tape. →  24</li> <li>● Try another tape.</li> <li>● Reverse the tape insertion orientation.</li> </ul>
<b>Sound is harsh or high frequencies are not reproduced.</b>	<ul style="list-style-type: none"> <li>● The head is dirty.</li> <li>● The tape is stretched or shrunk.</li> </ul>	<ul style="list-style-type: none"> <li>● Clean the head referring to "Maintenance". →  38</li> <li>● Try another tape.</li> </ul>
<b>Noise is noticeable.</b>	<ul style="list-style-type: none"> <li>● The tape head is magnetized.</li> <li>● External noise is induced.</li> <li>● A tape recorded with Dolby NR ON is being played on this unit.</li> </ul>	<ul style="list-style-type: none"> <li>● Demagnetize the head referring to "Maintenance". →  38</li> <li>● Install the system at a distance from other electric appliances and TV.</li> <li>● This unit can not play tapes recorded with Dolby NR ON with the correct sound quality</li> </ul>
<b>Sound vibrates.</b>	<ul style="list-style-type: none"> <li>● The capstans or pinch rollers are dirty.</li> <li>● The tape is wound irregularly.</li> </ul>	<ul style="list-style-type: none"> <li>● Clean the head referring to "Maintenance". →  38</li> <li>● Wind the tape again by fast forwarding, rewinding or playing from an end to the other. →  25</li> </ul>
<b>Recording cannot be started by pressing the record key.</b>	<ul style="list-style-type: none"> <li>● The recording protect tab of the cassette has been broken.</li> <li>● The cassette holder is not closed completely.</li> <li>● The tape is fully wound to one of the reels.</li> </ul>	<ul style="list-style-type: none"> <li>● Use a cassette with an unbroken recording protect tab or block the hole. →  7</li> <li>● Close the holder completely. →  24</li> <li>● Reverse the tape insertion orientation. →  24</li> </ul>



1. With some tapes, a squeaky noise is produced when the tape is stopped automatically. This is due to the tape protection function, and not a malfunction.
2. Do not use longer tape than 110 minutes tapes, for the tape is too thin and gets easily tangled.



### CD player

Symptom	Cause	Remedy
<b>A CD is placed in the player but it cannot be played.</b>	<ul style="list-style-type: none"> <li>● The disc is placed upside down.</li> <li>● The disc position is displaced.</li> <li>● The disc is extremely dirty.</li> <li>● The disc is scratched.</li> <li>● Dew is condensed on the optics lens.</li> </ul>	<ul style="list-style-type: none"> <li>● Place the disc properly, with the label side facing upward. →  16</li> <li>● Place the disc properly. →  16</li> <li>● Clean the disc referring to "Disc handling precautions". →  7</li> <li>● Try another disc. →  16</li> <li>● Refer to "Caution on condensation" and remove the condensation by evaporation. →  38</li> </ul>
<b>Sound is not produced.</b>	<ul style="list-style-type: none"> <li>● The disc has not been placed.</li> <li>● The player is not put to the play mode.</li> <li>● The disc is extremely dirty.</li> <li>● The disc is scratched.</li> </ul>	<ul style="list-style-type: none"> <li>● Place a disc in the CD player. →  16</li> <li>● Press the play key. →  16</li> <li>● Clean the disc referring to "Disc handling precautions". →  7</li> <li>● Try another disc. →  16</li> </ul>
<b>Sound skips.</b>	<ul style="list-style-type: none"> <li>● The disc is dirty.</li> <li>● The disc is scratched.</li> <li>● The player is subject to vibration.</li> </ul>	<ul style="list-style-type: none"> <li>● Clean the disc referring to "Disc handling precautions". →  7</li> <li>● Try another disc.</li> <li>● Install the unit in a place not subject to vibrations.</li> </ul>

### General

Symptom	Cause	Remedy
<b>No operation occurs when an operation key is pressed.</b>	<ul style="list-style-type: none"> <li>● The MULTI CONTROL setting mode is activated.</li> </ul>	<ul style="list-style-type: none"> <li>● Press the MENU key. →  10</li> </ul>

#### **WARNING NOTICE:**

IN MOST CASES IT IS AN INFRINGEMENT OF COPYRIGHT TO MAKE COPIES OF TAPES OR DISCS WITHOUT THE PERMISSION OF THE COPYRIGHT OWNERS. ANYONE WISHING TO COPY COMMERCIALY AVAILABLE TAPES OR DISC SHOULD CONTACT THE MECHANICAL COPYRIGHT

**Main unit****[ Amplifier section ]****(XD-A31/XD-302)**

Rated power output (U.S.A. and Canada)

30 watts per channel minimum RMS, both channels driven, at 6 Ω from 40 Hz to 14 kHz with no more than 0.9 % total harmonic distortion.

Effective output power during STEREO operation

U.S.A. and Canada

1 kHz, 10 % T.H.D., 6 Ω ..... 43 W + 43 W

**(XD-352/XD-372S)**

Effective output power during STEREO operation

1 kHz, 10 % T.H.D., 6 Ω ..... 43 W + 43 W

Rated output power during STEREO operation

Europe, U.K. and Russia

(DIN) 1 kHz, 0.7 % T.H.D., 6 Ω ..... 30 W + 30 W

Other countries

1 kHz, 1.0 % T.H.D., 6 Ω ..... 30 W + 30 W

Input sensitivity / impedance

AUX ..... 300 mV / 40 kΩ

Output level / impedance

(XD-A31/XD-302)

SUPER WOOFER PREOUT ..... 1.8 V / 0.6 kΩ

**[ Tuner section ]**

FM tuner section

Tuning frequency range ..... 87.5 MHz ~ 108 MHz

(For Russia) ..... ( 87.5 MHz ~ 108 MHz  
65.0 MHz ~ 74.0 MHz

AM (MW) Tuner section

Tuning frequency range

Europe, U.K. and Russia ..... 531 kHz ~ 1,602 kHz

U.S.A. and Canada ..... 530 kHz ~ 1,700 kHz

Other countries

9 kHz step ..... 531 kHz ~ 1,602 kHz

10 kHz step ..... 530 kHz ~ 1,610 kHz

LW Tuner section (For U. K.)

Tuning frequency range ..... 153 kHz ~ 279 kHz

SW Tuner section (XD-372S)

Tuning frequency range ..... 5.95 MHz ~ 17.9 MHz

**[ Cassette deck section ]**

Track ..... 4-track, 2-channel stereo

Recording system ..... AC bias system  
(Frequency: 105 kHz)

Heads

B deck Playback / recording head ..... 1

Erasing head ..... 1

A deck Playback head ..... 1

Motor ..... 1

**[ CD player section ]**

Laser ..... Semiconductor laser

Wow &amp; Flutter ..... Less than unmeasurable Limit

**[ General ]**

Power consumption ..... 150 W

Dimensions ..... W: 280 mm (11")

H: 330 mm (13")

D: 405 mm (15-15/16")

Weight (net) ..... (XD-A31/XD-302) 6.9kg (15.2 lb)  
(XD-352/XD-372S) 7.2kg (15.9 lb)**Speakers (LS-N302/LS-N352)**

Enclosure ..... Bass-reflex type

Speaker configuration

Woofers ..... 130 mm, cone type

Tweeters ..... 50 mm, cone type

Impedance ..... 6 Ω

Maximum input level ..... 43 W

Dimensions ..... W: 220 mm (8-11/16")

H: 330 mm (13")

D: 295 mm (11-5/8")

Weight (net) ..... 3.2 kg (7.1 lb) (1 piece)



1. KENWOOD follows a policy of continuous advancements in development. For this reason specifications may be changed without notice.
2. Sufficient performance may not be possible at very low temperatures (0°C or less).



---

# KENWOOD

***For your records***

Record the serial number, found on the back of the unit, in the spaces designated on the warranty card, and in the space provided below. Refer to the model and serial numbers whenever you call upon your dealer for information or service on this product.

Model \_\_\_\_\_ Serial Number \_\_\_\_\_